

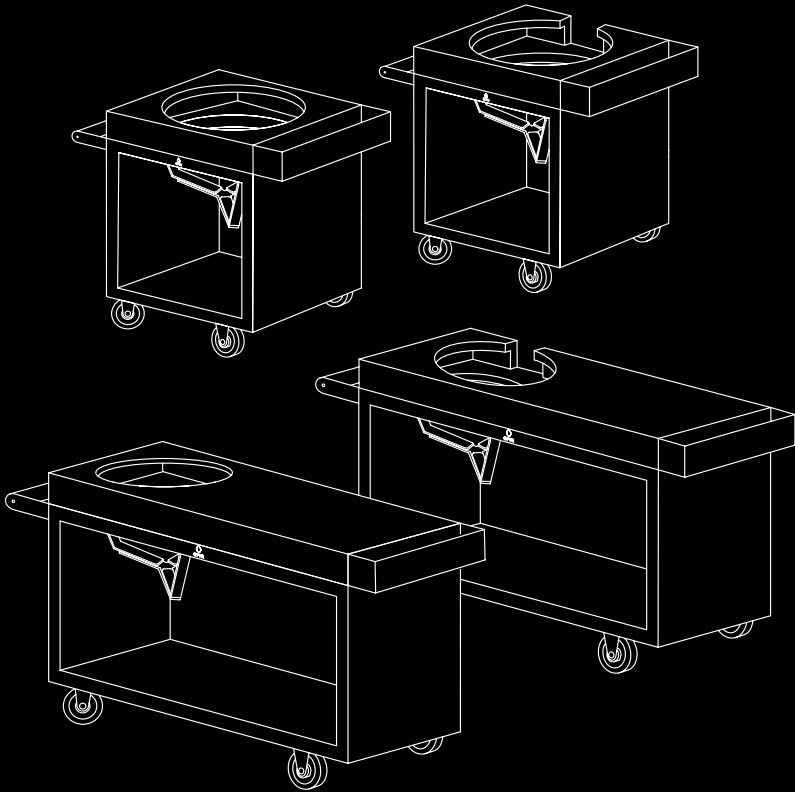

OFYR[®]

MANUAL



KAMADO TABLE PRO

BIG GREEN EGG & KAMADO JOE

EN	Your language can be found from page	4
DE	Ihre Sprache finden Sie ab Seite	12
FR	Trouvez votre langue à partir de la page	20
NL	Uw taal begint op pagina	28
ES	Su idioma comienza en página	36
IT	Le vostre lingue inizia a pagina	44



EN Your language not found? Please take a view with this QR-code.
DE Ihre Sprache nicht gefunden? Mit diesem QR-Code erhalten Sie weitere Information.
FR Vous ne trouvez pas la langue qu'il vous faut ? Veuillez utiliser ce code QR.
NL Uw taal niet gevonden? Probeer eens met deze QR-code.
ES ¿No encuentra su idioma? Eche un vistazo con este código QR.
IT Non hai trovato la tua lingua? Dai un'occhiata con questo QR-code.



TABLE OF CONTENT

1. INTRODUCTION	5
1.1 OFYR® Kamado Table 65 PRO and 135 PRO, parts and intended use	5
2. SAFETY AND SETUP INSTRUCTIONS	6
3. DISCLAIMERS	6
3.1 Safety and setup-, intended use- and maintenance instructions/tips	6
3.2 Corten steel	7
3.3 Black-coated steel	7
4. WARRANTY TERMS PER ELEMENT	7
5. WOODEN BLOCKS	8
5.1 Intended use	8
5.2 Maintenance tips	8
6. CONCRETE BLOCKS	9
6.1 Intended use	9
6.2 Maintenance tips	9
7. ASSEMBLY INSTRUCTIONS	10
7.1 OFYR® Kamado Table 65 PRO	10
7.2 OFYR® Kamado Table 135 PRO	11

SYMBOLS AND ICONS



Danger! Risk of serious or deadly injury or severe product damage.



Warning! Risk of injury or product damage.



Notice! Useful information.

1. INTRODUCTION

THANK YOU SO MUCH FOR BUYING AN OFYR® PRODUCT. THIS MANUAL CONTAINS ASSEMBLY INSTRUCTIONS, WARRANTY CONDITIONS AND ADDITIONAL INFORMATION ABOUT YOUR OFYR KAMADO TABLE 65 PRO AND 135 PRO.

1.1 OFYR® KAMADO TABLE 65 PRO AND 135 PRO, PARTS AND INTENDED USE

Equipped with a handle, 2 swivel casters (on the side of the handle) and 2 rigid casters, the OFYR® Kamado Table 65 PRO and 135 PRO include a Teak wooden or concrete chopping board for food preparation, handy accessories tray and options for under-counter storage. The chopping board contains a large hole with underneath a “nest” in which one can place either a Big Green Egg Large or a Kamado Joe Classic II.

The chopping board for the Kamado Joe Classic II has additionally at the rear end a cut out in which the hinge of the Kamado Joe Classic II does fit. The bottom of the nest is covered with felt for heat isolation reasons. The Teak wooden board must be cleaned by hand and must not be treated with any corrosive substances. After you clean it, you should store the table indoors, in a dry place with low humidity. Large temperature differences and humidity may cause the wood to warp.

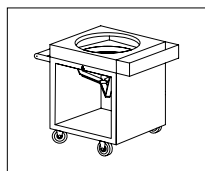

OFYR® KAMADO TABLE
CORTEN 65 PRO TEAK
WOOD BGE

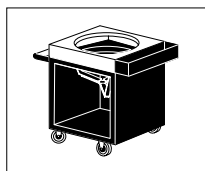

OFYR® KAMADO TABLE
BLACK 65 PRO TEAK WOOD
BGE

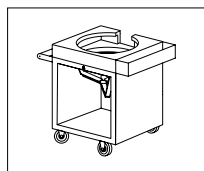

OFYR® KAMADO TABLE
CORTEN 65 PRO TEAK
WOOD KJ

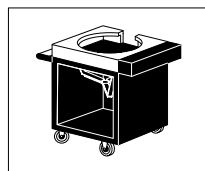

OFYR® KAMADO TABLE
BLACK 65 PRO TEAK
WOOD KJ

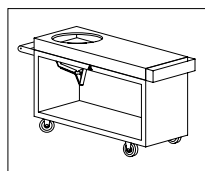

OFYR® KAMADO TABLE
CORTEN 135 PRO TEAK
WOOD BGE

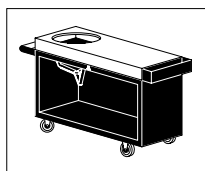

OFYR® KAMADO TABLE
BLACK 135 PRO TEAK WOOD
BGE

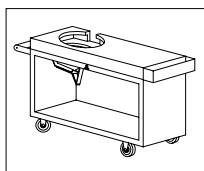

OFYR® KAMADO TABLE
CORTEN 135 PRO TEAK
WOOD KJ

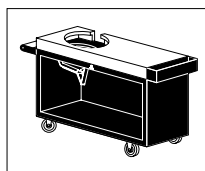

OFYR® KAMADO TABLE
BLACK 135 PRO TEAK
WOOD KJ

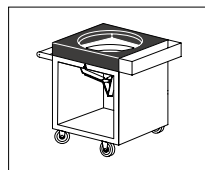

OFYR® KAMADO TABLE
CORTEN 65 PRO CONCRETE
BGE

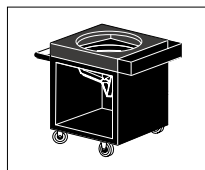

OFYR® KAMADO TABLE
BLACK 65 PRO CONCRETE
BGE

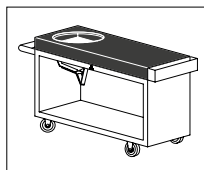

OFYR® KAMADO TABLE
CORTEN 135 PRO
CONCRETE BGE

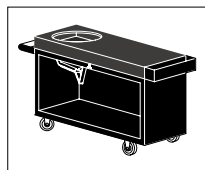

OFYR® KAMADO TABLE
BLACK 135 PRO
CONCRETE BGE

2. SAFETY AND SETUP INSTRUCTIONS



Due to the considerable weight of the elements unpacking and placing of the product should be done by at least 2 people.



While the corrosion is still superficial, the Corten steel elements may cause orange stains on clothes, skin, and the surface they stand on. When it rains, corrosive water may also run off these elements, which may permanently stain light-toned stone or wooden surfaces.



When mounting the parts of your OFYR® Kamado Table PRO do not use the handle to tilt the base. The handle is only suited to pull or push the device once the wheels are mounted.



The OFYR® Kamado Table Black 65 PRO and 135 PRO are more sensitive to damage during setup and use because of its coating.



Only place your OFYR® Kamado Table PRO on a hard, leveled, heat resistant and stable surface.



The wheels of your OFYR® Kamado Table PRO unit are not equipped with breaks. If the surface is not completely level, wedges should be put under the wheels in order to be certain that the table cannot move.



Never leave your OFYR® Kamado Table PRO unit unattended during use.



Keep children and pets away from the Kamado Table PRO during use.



Never use an OFYR® Kamado Table PRO including a Cooking Unit indoors or in a partially or fully closed-off space. This causes an excess of dangerous fumes that may result in carbon monoxide poisoning.



Make sure the area around your OFYR® Kamado Table PRO is clear of any flammable materials.



Always store the Kamado Table PRO indoors in a dry place with low humidity. This because wood is a natural product and is always liable to warp somewhat.



3. DISCLAIMERS

3.1 SAFETY AND SETUP, INTEND USE- AND MAINTENANCE INSTRUCTIONS/TIPS

We are not liable for any injuries or damages as a consequence of not following our safety and setup-, intended use- and maintenance instructions/tips.

3.2 CORTEN STEEL

OFYR® Kamado Table Corten 65 PRO and 135 PRO are made of Corten steel: a metal with a natural layer of corrosion that protects against rust perforation. OFYR Kamado Tables Corten come with the additional service that the corrosion process has already started by the time they are delivered. Upon delivery, it takes another 6-12 months for the initial corrosion to turn into a fully protective layer.

-  The unit's color may change over time as the corrosion process may not yet have fully unfolded. We are not liable for any color changes.
-  Any Corten steel components that are less corroded than others upon delivery are not eligible for replacement. All components will corrode naturally over time under influence of the weather. We are not liable for any differences of corrosion between different elements.
-  While the corrosion is still superficial, the Corten steel elements may cause orange stains on clothes, skin, and the surface they stand on. When it rains, corrosive water may also run off these elements, which may permanently stain light-toned stone or wooden surfaces. We are not liable for stains as a consequence of corrosion.

3.3 BLACK-COATED STEEL

-  Please note that the OFYR® Kamado Tables Black PRO have a coating and are thus more sensitive to damage during setup and use. We are not liable for any damage or consequential damage resulting from the setup or use of your OFYR® Kamado Table Black 65 PRO and Black 135 PRO. For small repairs the OFYR® Kamado Tables Black PRO come with a free Repair Bottle.

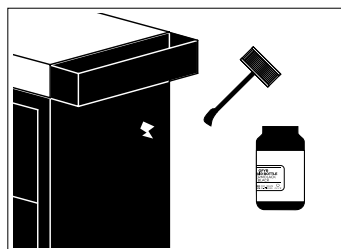

-  Due to weather and sunlight the coating can be subject to discolouration. We are not liable for such discolouration.

4. WARRANTY TERMS PER ELEMENT

A limited lifetime guarantee applies to the material and construction of the OFYR® Kamado Tables PRO for the original buyers or owners, provided that they purchased their unit from an authorised dealer and registered their warranty in the required manner through OFYR Club at www.ofyr.club.

	B2C	B2B
Corten steel elements	5 years	3 years
Coated steel elements	2 years	1 year
Wooden blocks	2 years	1 year
Wheels	2 years	1 year

This warranty covers manufacturing defects. It applies to the original buyers or owners of an OFYR® Kamado Table PRO, provided that

- They purchased their unit from an authorized dealer
- They assembled, used and maintained the OFYR® Kamado Table PRO according to the instructions in this manual.



NOT COVERED BY WARRANTY

- Wear, corrosion, deformation and discolouration of parts exposed to fire;
- Corrosion and discolouration caused by external influences;
- Visual irregularities inherent to the manufacturing process;
- Damages caused by not following our safety and setup-, intended use- and maintenance instructions/tips.

5. WOODEN BLOCKS

All wooden blocks are made from Teak wood. Teak's high oil content, high tensile strength and tight grain make it particularly suitable where weather resistance is desired.

5.1 INTENDED USE

- Wood is a natural product and should therefore be stored indoors.
- Do not use the wooden boards as a chopping board.
Using sharp objects causes irreparable damage.
- Do not use heavy objects as exerting large forces on the wooden block can cause irreparable damage.

5.2 MAINTENANCE TIPS

- Before the first use: Clean the worktop thoroughly with a mild detergent.
- Use a damp cloth and mild detergent for daily cleaning.
Make sure to clean the block after every use.
- Cleaning of persistent stains: use a damp cloth or a sponge (no scourer) with a mild detergent.
- Clean the wood in the direction of the nerve to retain the quality of the material.
- Dry the block after cleaning.
- All teak wooden boards have been treated with vegetable oil in order to protect them against dirt and humidity. We recommend that users of these products will also treat these boards at least once a year with such oil and in case of frequent use more often.



Do not clean the wooden boards with corrosive substances or clean them in a dishwasher.



The Kamado Tables should be stored indoors, in a dry place with low humidity. Large temperature differences and humidity may cause the wood to warp.

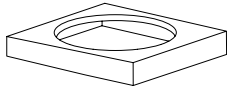

BLOCK FOR OFYR KAMADO TABLE
65 PRO TEAK WOOD BGE

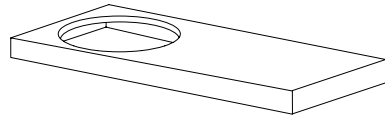

BLOCK FOR OFYR KAMADO TABLE
135 PRO TEAK WOOD BGE

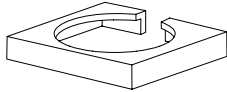

BLOCK FOR OFYR KAMADO TABLE
65 PRO TEAK WOOD KJ

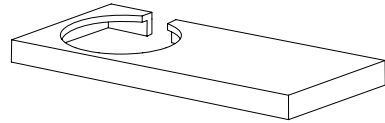

BLOCK FOR OFYR KAMADO TABLE
135 PRO TEAK WOOD KJ

6. CONCRETE BLOCKS

The concrete block is cast and wax-coated. Concrete is quite porous, allowing dirt to penetrate. The wax layer prevents this to a great extent. The concrete can remain outdoors permanently.

6.1 INTENDED USE

- Concrete is weather proof and can be stored outdoors on a permanent basis.
- We recommend using a cutting board to prevent your knives from getting blunt.
- The concrete can be cleaned with luke warm water and a mild detergent.
- Never stand on the concrete block.

6.2 MAINTENANCE TIPS

- Before the first use: clean the board with luke warm water and a mild detergent.
- Use a damp cloth with a mild detergent for daily cleaning.
Make sure to clean the block after use.
- The wax layer can dry out and should be renewed in order to prevent dirt to penetrate.



BLOCK FOR OFYR KAMADO TABLE
65 PRO CONCRETE BGE

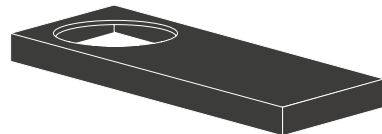

BLOCK FOR OFYR KAMADO TABLE
135 PRO CONCRETE BGE

7. ASSEMBLY INSTRUCTIONS

7.1 OFYR® KAMADO TABLE 65 PRO

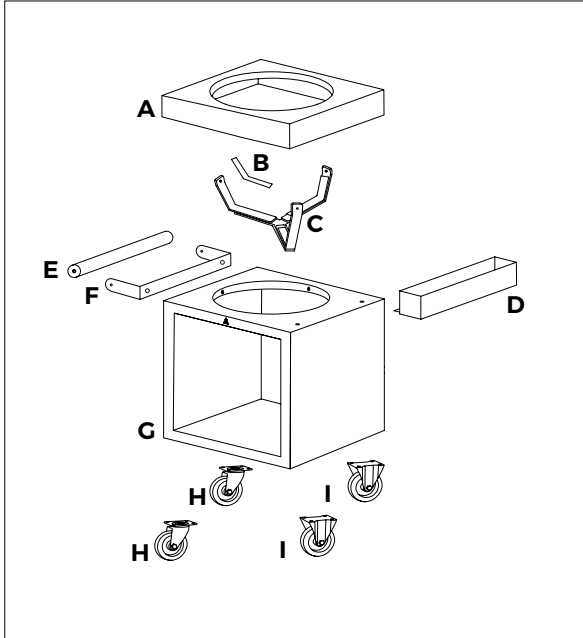

PARTS LIST

- A. Wooden block
- B. Felt (3x)
- C. Nest
- D. Tooltray
- E. Wooden part of the handle
- F. Metal part of the handle
- G. Base
- H. Swivel casters
- I. Rigid casters

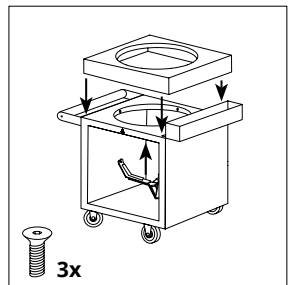
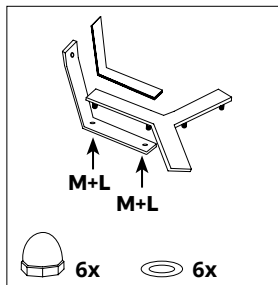
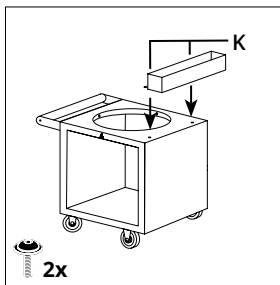
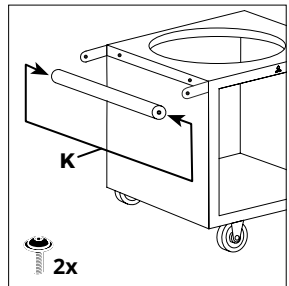
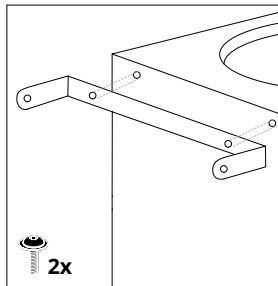
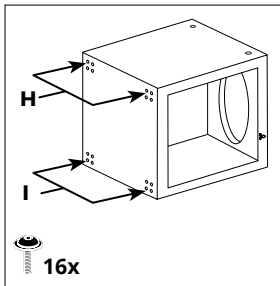
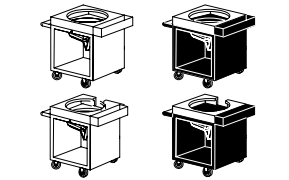
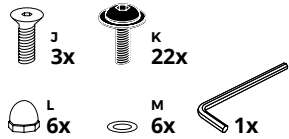

7. ASSEMBLY INSTRUCTIONS

7.2 OFYR® KAMADO TABLE 135 PRO

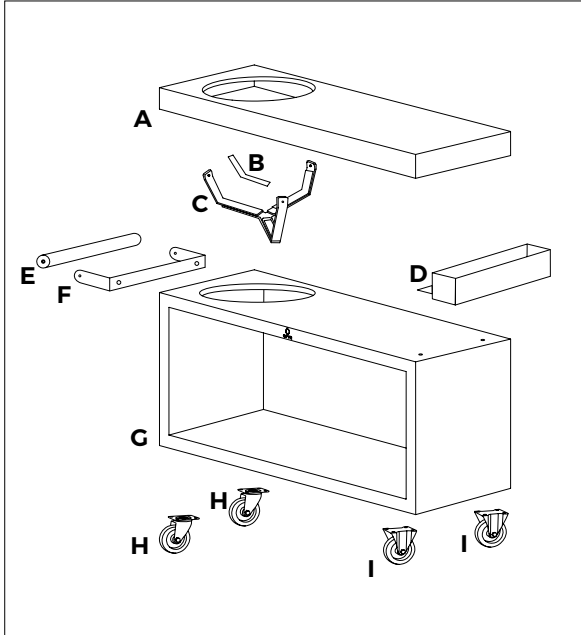

PARTS LIST

- A. Wooden block
- B. Felt (3x)
- C. Nest
- D. Tooltray
- E. Wooden part of the handle
- F. Metal part of the handle
- G. Base
- H. Swivel casters
- I. Rigid casters

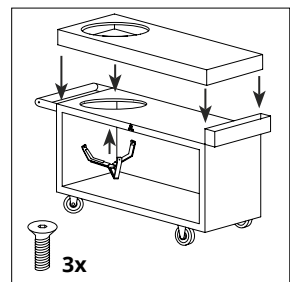
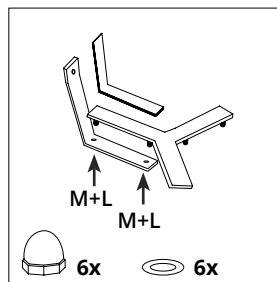
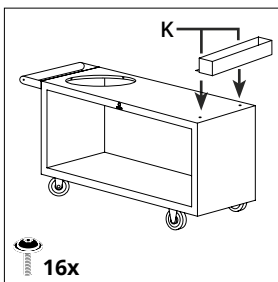
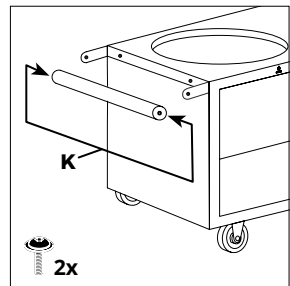
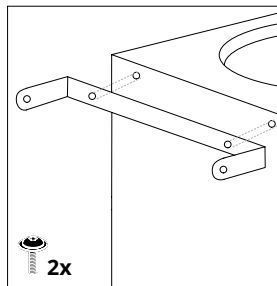
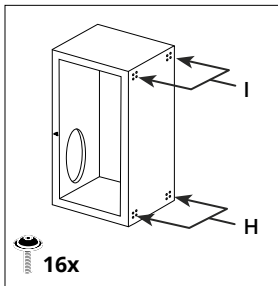
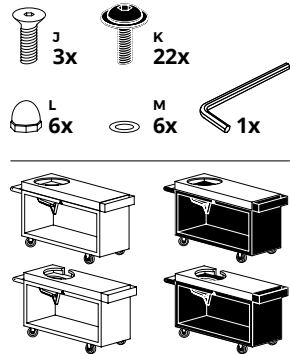

INHALTSVERZEICHNIS

1. EINLEITUNG	13
1.1 OFYR® Kamado Table 65 PRO und 135 PRO, Teile und Gebrauchshinweise	13
2. SICHERHEITS- UND AUFBAUHINWEISE	14
3. HAFTUNGSAUSSCHLUSS	14
3.1 Sicherheits- und Aufstellungs-, Gebrauchs- und Wartungsanweisungen/Tipps	14
3.2 Cortenstahl	15
3.3 Schwarz beschichteter Stahl	15
4. GARANTIEBEDINGUNGEN PRO ELEMENT	15
5. HOLZELEMENTE	16
5.1 Vorgesehene Verwendung	16
5.2 Wartungstipps	16
6. BETON-ELEMENTE	17
6.1 Vorgesehene Verwendung	17
6.2 Wartungstipps	17
7. MONTAGEANLEITUNGEN	18
7.1 OFYR® Kamado Table 65 PRO	18
7.2 OFYR® Kamado Table 135 PRO	19

SYMBOLE UND IKONEN



Gefahr! Gefahr von schweren oder tödlichen Verletzungen oder schweren Produktschäden.



Warnung! Verletzungsgefahr oder Produktschäden



Zum Beachten! Nützliche Informationen.

1. EINLEITUNG

VIELEN DANK, DASS SIE EIN OFYR® PRODUKT GEKAUFT HABEN. DIESES HANDBUCH ENTHÄLT ANWEISUNGEN ZUR EINRICHTUNG, GARANTIEBEDINGUNGEN UND ZUSÄTZLICHE INFORMATIONEN ÜBER IHR OFYR KAMADO TABLE 65 PRO UND 135 PRO.

1.1 OFYR® KAMADO TABLE 65 PRO UND 135 PRO, TEILE UND GEBRAUCHSHINWEISE

Ausgestattet mit einem Handgriff, 2 Lenkrollen (an der Seite des Handgriffs) und 2 starren Rollen. OFYR® Kamado Table 65 PRO und 135 PRO enthalten zusätzlich ein dunkelgraues Teakholz- oder Betonschneidbrett für die Essenzubereitung und ein praktisches Zubehöralter und Möglichkeiten für die Holzlagerung unter dem Grill. Die Holzauflage enthält ein großes Loch mit einem darunter liegenden "Nest", in das man entweder ein Big Green Egg Large oder einen Kamado Joe Classic II stellen kann.

Die Holzauflage für den Kamado Joe Classic II hat zusätzlich am hinteren Ende einen Ausschnitt, in den der Deckellifter des Kamado Joe Classic II passt. Der Boden des Nestes ist aus Gründen der Wärmeisolation mit Vlies abgedeckt. Das Teakholzbrett muss von Hand gereinigt werden und darf nicht mit scharfen Reinigungsmitteln bearbeitet werden. Wir empfehlen Ihnen die Holzauflage bei Bedarf mit einem lebensmittelechten Holzöl nachzuölen. Wenn Sie ihn gereinigt haben, sollten Sie den Tisch im Haus an einem trockenen Ort mit geringer Luftfeuchtigkeit aufbewahren. Große Temperaturunterschiede und Feuchtigkeit können dazu führen, dass sich das Holz verzieht.

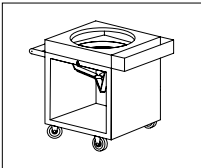

OFYR® KAMADO TABLE
CORTEN 65 PRO TEAKHOLZ
BGE



OFYR® KAMADO TABLE
BLACK 65 PRO TEAKHOLZ
BGE

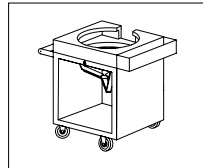

OFYR® KAMADO TABLE
CORTEN 65 PRO TEAKHOLZ
KJ

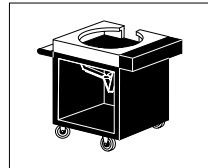

OFYR® KAMADO TABLE
BLACK 65 PRO TEAKHOLZ
KJ

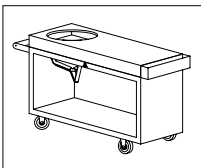

OFYR® KAMADO TABLE
CORTEN 135 PRO TEAKHOLZ
BGE

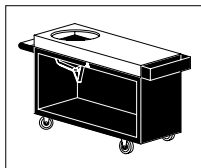

OFYR® KAMADO TABLE
BLACK 135 PRO TEAKHOLZ
BGE

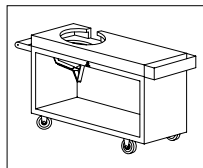

OFYR® KAMADO TABLE
CORTEN 135 PRO TEAKHOLZ
KJ

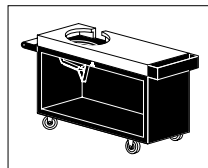

OFYR® KAMADO TABLE
BLACK 135 PRO TEAKHOLZ
KJ

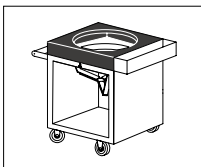

OFYR® KAMADO TABLE
CORTEN 65 PRO BETON
BGE

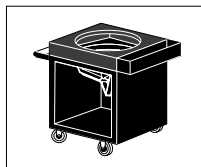

OFYR® KAMADO TABLE
BLACK 65 PRO BETON BGE

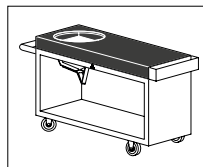

OFYR® KAMADO TABLE
CORTEN 135 PRO BETON
BGE

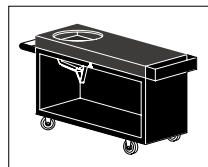

OFYR® KAMADO TABLE
BLACK 135 PRO
BETON BGE

2. SICHERHEITS- UND AUFBAUHINWEISE



Aufgrund des beträchtlichen Gewichts der Einzelteile sollte das Auspacken, Aufbauen und Platzieren des Produkts von mindestens 2 Personen vorgenommen werden.



Auch wenn die Korrosion nur oberflächlich ist, können die Cortenstahl-Elemente orange angefarbene Flecken auf Kleidung, Haut und der Standfläche, auf der sie stehen, verursachen. Wenn es regnet, kann auch Rostwasser von diesen Elementen ablaufen, was zu dauerhaften Flecken auf hell getönten Stein- oder Holzoberflächen führen kann.



Verwenden Sie bei der Montage der einzelnen Teile Ihres OFYR® Kamado Table PRO nicht den Griff zum Kippen des Sockels. Der Griff eignet sich erst nach der Montage der Räder zum Ziehen oder Schieben des Gerätes.



Aufgrund ihrer Beschichtung ist der OFYR® Kamado Table Black 65 PRO und 135 PRO während des Aufbaus und bei der Benutzung vor Beschädigungen zu schützen.



Stellen Sie Ihren OFYR® Kamado Table PRO nur auf eine harte, ebene, hitzebeständige und stabile Oberfläche.



Die Räder Ihres OFYR® Kamado Table PRO sind nicht mit Bremsen ausgestattet. Wenn die Standfläche nicht komplett eben ist, sollten Keile unter die Räder gelegt werden, um sicher zu sein, dass der OFYR® Kamado Table PRO nicht wegrollen kann.



Lassen Sie Ihren OFYR® Kamado Table PRO während des Gebrauchs niemals unbeaufsichtigt.



Halten Sie Kinder und Haustiere vom Kamado Table PRO während des Gebrauchs.



Verwenden Sie einen OFYR® Kamado Table PRO niemals in Innenräumen oder in einem teilweise oder vollständig geschlossenen Raum. Dies führt zu einem Übermaß an gefährlichen Dämpfen, die zu einer Kohlenmonoxidvergiftung führen können.



Stellen Sie sicher, dass der Bereich um Ihren OFYR® Kamado Table PRO frei von brennbaren Materialien ist.



Der Holzklotz sollte in Innenräumen an einem trockenen Ort mit geringer Luftfeuchtigkeit gelagert werden. Das liegt daran, dass Holz ein Naturprodukt ist und sich immer etwas verziehen kann.

3. HAFTUNGSAUSSCHLUSS

3.1 SICHERHEITS- UND AUFSTELLUNGS-, GEBRAUCHS- UND WARTUNGSANWEISUNGEN/TIPPS

Wir sind nicht haftbar für Verletzungen oder Schäden als Folge der Nichtbeachtung unserer Sicherheits- und Aufstellungs-, bestimmungsgemäßen Verwendungs- und Wartungsanweisungen/Tipps.

3.2 CORTENSTAHL

OFYR® Kamado Table Corten 65 PRO und 135 PRO werden aus Cortenstahl hergestellt: ein Metall mit einer natürlichen Korrosionsschicht, die vor Durchrostung schützt. OFYR® Kamado Table Corten 65 PRO und 135 PRO werden mit dem zusätzlichen Service geliefert, dass der Korrosionsprozess bereits begonnen hat, wenn sie ausgeliefert werden. Nach der Lieferung dauert es weitere 6-12 Monate, bis die anfängliche Korrosion sich in eine vollständig schützende Schicht verwandelt.



Die Farbe der Anlage kann sich im Laufe der Zeit ändern, da der Korrosionsprozess noch nicht vollständig entfaltet ist. Wir haften nicht für eventuelle Farbveränderungen.



Cortenstahl-Komponenten, die bei der Lieferung weniger korrodiert sind als andere, können nicht ersetzt werden. Alle Komponenten korrodieren im Laufe der Zeit unter Witterungseinfluss auf natürliche Weise. Wir haften nicht für Korrosionsunterschiede zwischen verschiedenen Elementen.



Während die Korrosion noch oberflächlich ist, können die Cortenstahl-Elemente orangefarbene Flecken auf Kleidung, Haut und der Oberfläche, auf der sie stehen, verursachen. Wenn es regnet, kann auch korrosives Wasser von diesen Elementen ablaufen, was zu dauerhaften Flecken auf hell getönten Stein- oder Holzoberflächen führen kann. Wir haften nicht für Flecken als Folge von Korrosion.

3.3 SCHWARZ BESCHICHTETER STAHL



Bitte beachten Sie, dass die OFYR® Kamado Tables Black PRO eine Beschichtung haben und daher empfindlicher auf Beschädigungen beim Aufbau und Gebrauch reagieren. Wir haften nicht für eventuelle Folgeschäden, die durch den Aufbau oder den Gebrauch Ihrer OFYR® Kamado Table Black 65 PRO und Black 135 PRO entstehen. Für kleinere Reparaturen werden die OFYR® Kamado Tables Black PRO mit einer kostenlosen Lackstift geliefert.

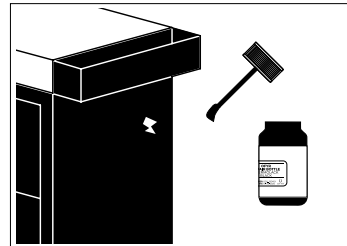

Durch Witterung und Sonneneinstrahlung kann es zu Verfärbungen der Beschichtung kommen. Für solche Verfärbungen übernehmen wir keine Haftung.

4. GARANTIEBEDINGUNGEN PRO ELEMENT

Eine beschränkte lebenslange Garantie gilt für das Material und die Konstruktion aller OFYR® Kamado Tables PRO für die ursprünglichen Käufer oder Besitzer, vorausgesetzt, dass sie ihre Einheit von einem autorisierten Händler gekauft und ihre Garantie in der erforderlichen Weise über den OFYR-Club unter www.ofyr.club registriert haben.

	B2C	B2B
Elemente aus Cortenstahl	5 Jahre	3 Jahre
Elemente aus Cortenstahl	2 Jahre	1 Jahr
Holzelemente	2 Jahre	1 Jahr
Räder	2 Jahre	1 Jahr

Diese Garantie deckt Herstellungsfehler ab. Sie gilt für die ursprünglichen Käufer oder Besitzer eines OFYR® Kamado Table PRO, vorausgesetzt, dass

- Sie haben ihr Gerät bei einem autorisierten Händler gekauft.
- Sie haben den OFYR® Kamado Table PRO gemäß den Anweisungen in diesem Handbuch zusammengesetzt, verwendet und gewartet.



NICHT DURCH GARANTIE ABGEDECKT

- Abnutzung, Korrosion, Verformung und Verfärbung von Teilen, die dem Feuer ausgesetzt sind;
- Korrosion und Verfärbung durch äußere Einflüsse;
- Dem Herstellungsprozess inhärente visuelle Unregelmäßigkeiten;
- Schäden, die durch die Nichtbeachtung unserer Sicherheits- und Aufstellungs-, bestimmungsgemäßen Verwendungs- und Wartungsanweisungen/Tipps entstehen.

5. HOLZELEMENTE

Alle Holzelemente sind aus Teakholz gefertigt. Der hohe Ölgehalt, die hohe Zugfestigkeit und die dichte Maserung von Teakholz machen es besonders geeignet, wo Wetterbeständigkeit gefragt ist.

5.1 VORGESEHENE VERWENDUNG

- Holz ist ein Naturprodukt und sollte daher in Innenräumen gelagert werden.
- Verwenden Sie die Holzbretter nicht als Schneidebrett. Die Verwendung scharfer Gegenstände verursacht irreparable Schäden.
- Verwenden Sie keine schweren Gegenstände, da das Ausüben großer Kräfte auf das Holzelement irreparable Schäden verursachen kann.

5.2 WARTUNGSTIPPS

- Vor der ersten Benutzung: Reinigen Sie die Arbeitsplatte gründlich mit einem milden Reinigungsmittel.
- Verwenden Sie für die tägliche Reinigung ein feuchtes Tuch und ein mildes Reinigungsmittel. Achten Sie darauf, den Block nach jedem Gebrauch zu reinigen.
- Reinigung von hartnäckigen Flecken: Verwenden Sie ein feuchtes Tuch oder einen Schwamm (kein Scheuermittel) mit einem milden Reinigungsmittel.
- Reinigen Sie das Holz in Richtung des Nerven, um die Qualität des Materials zu erhalten.
- Trocknen Sie den Block nach der Reinigung.
- Alle Teakholzbretter wurden mit Pflanzenöl behandelt, um sie vor Schmutz und Feuchtigkeit zu schützen. Wir empfehlen den Anwendern dieser Produkte, auch diese Bretter mindestens einmal im Jahr mit diesem Öl zu behandeln und bei häufiger Verwendung öfter.



Reinigen Sie die Holzbretter nicht mit ätzenden Substanzen oder in der Spülmaschine.



Der Holzklotz sollte in Innenräumen an einem trockenen Ort mit geringer Luftfeuchtigkeit gelagert werden. Große Temperatur- und Feuchtigkeitsunterschiede können zum Verziehen des Holzes führen.

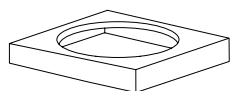

BLOCK FOR OFYR® KAMADO TABLE
65 PRO TEAKHOLZ BGE

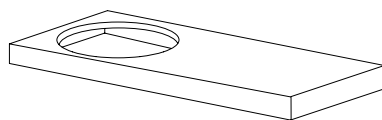

BLOCK FOR OFYR® KAMADO TABLE
135 PRO TEAKHOLZ BGE

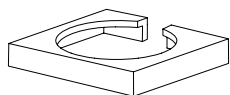

BLOCK FOR OFYR® KAMADO TABLE
65 PRO TEAKHOLZ KJ

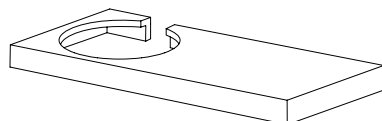

BLOCK FOR OFYR® KAMADO TABLE
135 PRO TEAKHOLZ KJ

6. BETON-ELEMENTE

Die Betonsteine werden gegossen und mit Wachs beschichtet. Beton ist recht porös, so dass Schmutz eindringen kann. Die Wachsschicht verhindert dies weitestgehend. Der Beton kann dauerhaft im Freien bleiben.

6.1 VORGESEHENE VERWENDUNG

- Beton ist witterungsbeständig und kann dauerhaft im Freien gelagert werden.
- Wir empfehlen die Verwendung eines Schneidebrettes, um zu verhindern, dass Ihre Messer stumpf werden.
- Der Beton kann mit lauwarmem Wasser und einem milden Reinigungsmittel gereinigt werden.
- Stellen Sie sich niemals auf das Beton-Element.

6.2 WARTUNGSTIPPS

- Vor dem ersten Gebrauch: Reinigen Sie den Betonstein mit lauwarmem Wasser und einem milden Reinigungsmittel.
- Verwenden Sie zur täglichen Reinigung ein feuchtes Tuch mit einem milden Reinigungsmittel. Achten Sie darauf, den Block nach dem Gebrauch zu reinigen.
- Die Wachsschicht kann austrocknen und sollte erneuert werden, um das Eindringen von Schmutz zu verhindern.



BLOCK FOR OFYR KAMADO TABLE
65 PRO BETON BGE

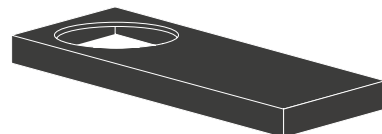

BLOCK FOR OFYR KAMADO TABLE
135 PRO BETON BGE

7. MONTAGEANLEITUNGEN

7.1 OFYR® KAMADO TABLE 65 PRO

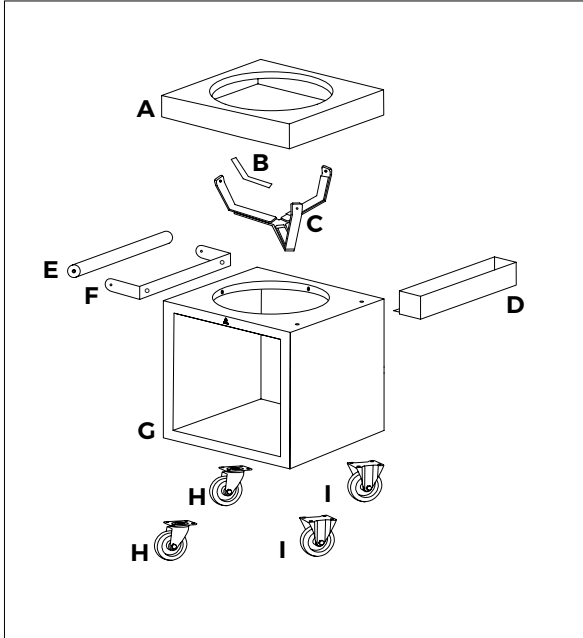

TEILLISTE

- A. Holzauflege
- B. Filzband (3x)
- C. Nest
- D. Tooltray
- E. Hölzerner Teil des Stiels
- F. Teil des Griffs aus Cortenstahl
- G. Sockel
- H. Lenkrollen
- I. Starre Rollen

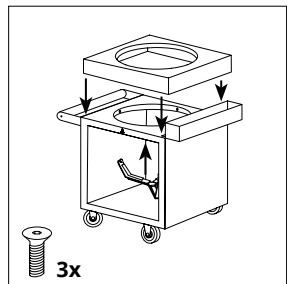
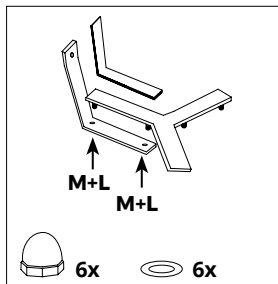
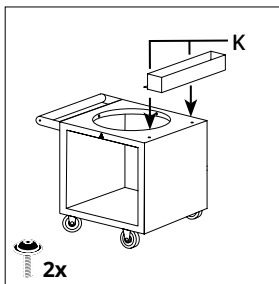
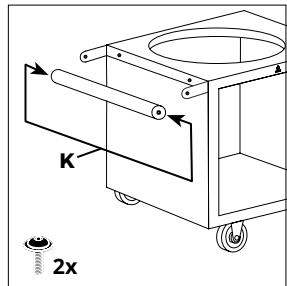
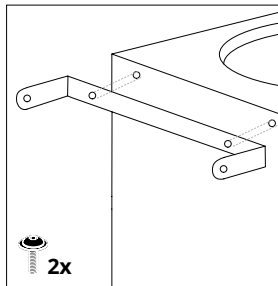
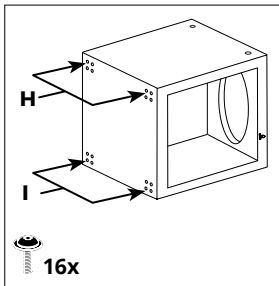
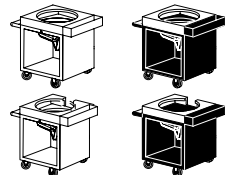
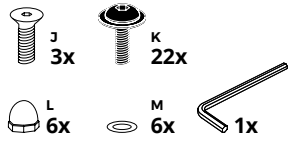

7. MONTAGEANLEITUNGEN

7.2 OFYR® KAMADO TABLE 135 PRO

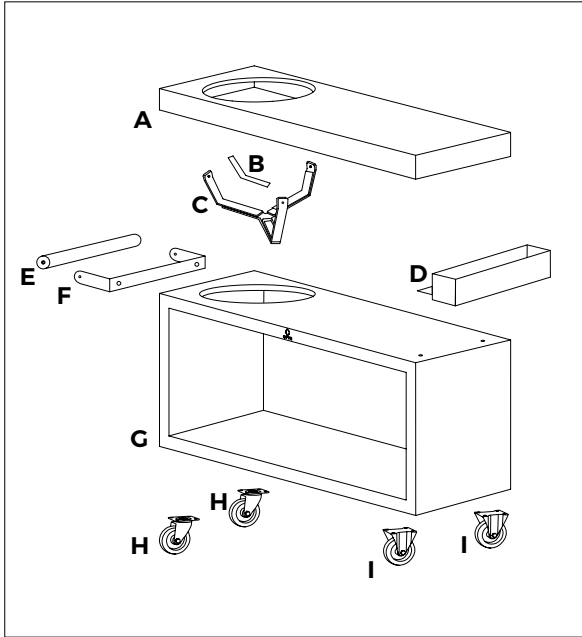

TEILLISTE

- A. Holzauflege
- B. Filzband (3x)
- C. Nest
- D. Tooltray
- E. Hölzerner Teil des Stiels
- F. Teil des Griffs aus Cortenstahl
- G. Sockel
- H. Lenkrollen
- I. Starre Rollen

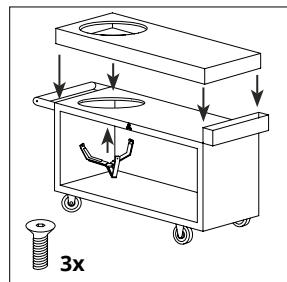
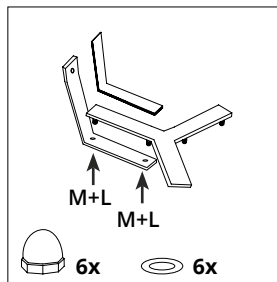
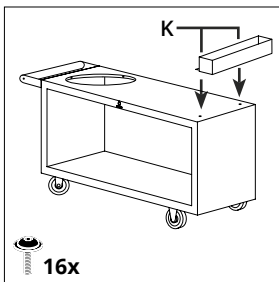
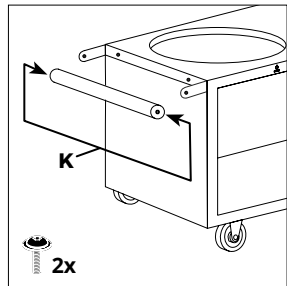
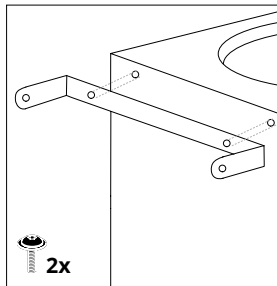
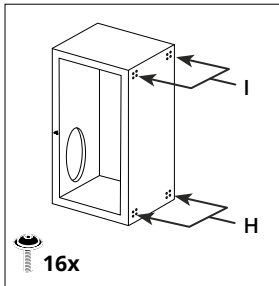
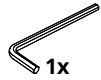
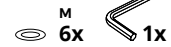

SOMMAIRE

1. INTRODUCTION	21
1.1 OFYR® Kamado Table 65 PRO et 135 PRO, pièces et usage conforme	21
2. INSTRUCTIONS DE SÉCURITÉ ET D'INSTALLATION	22
3. AVERTISSEMENTS	22
3.1 Conseils/Instructions de sécurité, d'installation, d'utilisation et d'entretien	22
3.2 Acier Corten	23
3.3 Acier laqué noir	23
4. CONDITIONS DE GARANTIE PAR ÉLÉMENT	23
5. PLANS DE TRAVAIL EN BOIS	24
5.1 Usage conforme	24
5.2 Conseils d'entretien	24
6. PLANS DE TRAVAIL EN CONCRETE	25
6.1 Usage conforme	25
6.2 Conseils d'entretien	25
7. INSTRUCTIONS D'INSTALLATION	26
7.1 OFYR® Kamado Table 65 PRO	26
7.2 OFYR® Kamado Table 135 PRO	27

SYMBOLES ET ICÔNES



Danger! Risque de blessures graves ou mortelles, ou d'endommagement sévère du produit.



Avertissement ! Risque de blessures ou d'endommagement du produit.



Remarque ! Informations utiles.

1. INTRODUCTION

NOUS VOUS REMERCIONS D'AVOIR ACHETÉ UN PRODUIT OFYR®. CE MANUEL CONTIENT LES INSTRUCTIONS D'INSTALLATION, LES CONDITIONS DE LA GARANTIE AINSI QUE DES INFORMATIONS SUPPLÉMENTAIRES SUR VOTRE OFYR KAMADO TABLE 65 PRO AND 135 PRO.

1.1 OFYR® KAMADO TABLE 65 PRO & 135 PRO, PIÈCES ET USAGE CONFORME

Il est équipé d'une poignée, de 2 roues pivotantes (sur le côté de la poignée) et de 2 roues fixes. L'OFYR® Kamado Table 65 PRO et 135 PRO comprend également un plan de travail en bois de teck ou en béton de couleur gris anthracite qui conviendra pour toutes vos préparations, un bac de rangement pour les accessoires et offre la possibilité de stocker du bois dans le socle. Le plan de travail contient une large niche qui peut accueillir à la fois un Big Green Egg Large ou un Kamado Joe Classic II.

La planche à découper du Kamado Joe Classic II a une encoche à l'arrière dans laquelle s'insère la charnière du Kamado Joe Classic II. Le fond du Kamado Joe est recouvert de feutre pour l'isolation thermique. Le plan de travail en bois de teck doit être nettoyé à la main et ne doit pas être traité avec un détergent corrosif. Après le nettoyage, le plan de travail doit être stocké à l'intérieur dans un endroit sec et peu humide. De grandes différences de température et d'humidité peuvent entraîner une déformation du bois.

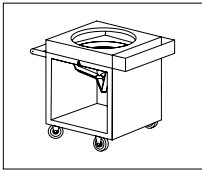

OFYR® KAMADO TABLE
CORTEN 65 PRO BOIS DE
TECK BGE

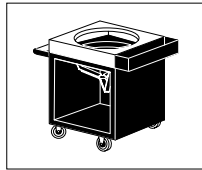

OFYR® KAMADO TABLE
BLACK 65 PRO BOIS DE
TECK BGE

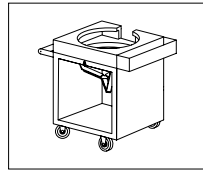

OFYR® KAMADO TABLE
CORTEN 65 PRO BOIS DE
TECK KJ

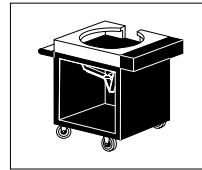

OFYR® KAMADO TABLE
BLACK 65 PRO BOIS DE
TECK KJ

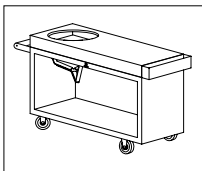

OFYR® KAMADO TABLE
CORTEN 135 PRO BOIS DE
TECK BGE

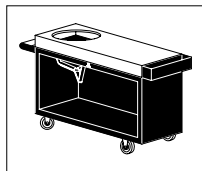

OFYR® KAMADO TABLE
BLACK 135 PRO BOIS DE
TECK BGE

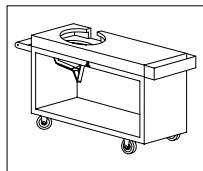

OFYR® KAMADO TABLE
CORTEN 135 PRO BOIS DE
TECK KJ

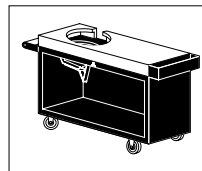

OFYR® KAMADO TABLE
BLACK 135 PRO BOIS DE
TECK KJ

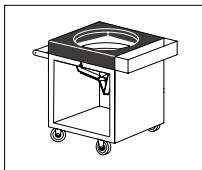

OFYR® KAMADO TABLE
CORTEN 65 PRO BÉTON
BGE



OFYR® KAMADO TABLE
BLACK 65 PRO BÉTON
BGE

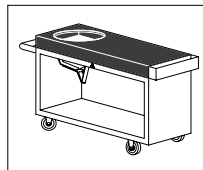

OFYR® KAMADO TABLE
CORTEN 135 PRO BÉTON
BGE

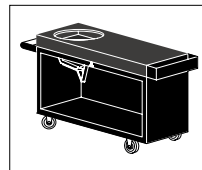

OFYR® KAMADO TABLE
BLACK 135 PRO
BÉTON BGE

2. INSTRUCTIONS DE SÉCURITÉ ET D'INSTALLATION



En raison du poids considérable des éléments, le déballage et l'installation du produit doivent être effectués par au moins 2 personnes.



Tant que la corrosion reste superficielle, les éléments en acier Corten peuvent provoquer des taches sur les vêtements, la peau et la surface sur laquelle ils reposent. En cas de pluie, l'eau corrosive peut également s'écouler de ces éléments, ce qui provoquerait des taches permanentes sur les surfaces en pierre claire ou en bois.



Lorsque vous assemblez les différentes parties de votre unité de cuisson OFYR® Kamado Table PRO, veillez à ne pas utiliser la poignée pour faire basculer le socle. La poignée a été conçue uniquement pour tirer ou pousser l'appareil une fois que ses roues ont été montées.



L'unité de cuisson OFYR® Kamado Table Black 65 PRO et 135 PRO est plus sensible aux dommages lors de l'installation en raison de son revêtement.



Placez votre unité de cuisson OFYR® Kamado Table PRO sur une surface dure, plate, résistante à la chaleur et stable.



Les roues de votre unité de cuisson OFYR® Kamado Table PRO ne sont pas équipées de freins. Si la surface n'est pas entièrement à niveau, il convient de placer des cales sous les roues pour éviter que l'unité de cuisson ne bouge."



Ne laissez jamais votre OFYR® Kamado Table PRO sans surveillance pendant l'utilisation.



Tenez les enfants et les animaux domestiques éloignés de la OFYR® Kamado Table PRO pendant l'utilisation.



N'utilisez jamais l'OFYR® Kamado Table PRO à l'intérieur ou dans un espace partiellement ou entièrement fermé. Ceci entraînerait un excès de fumées nocives susceptibles de provoquer un empoisonnement au monoxyde de carbone.



Assurez-vous que la zone autour de l'OFYR® Kamado Table PRO est exempte de matériaux inflammables.



Stockez toujours l'OFYR® Kamado Table PRO à l'intérieur dans un endroit sec et peu humide. Le bois est un produit naturel et peut donc toujours se déformer.



3. AVERTISSEMENTS

3.1 CONSEILS/INSTRUCTIONS EN MATIÈRE DE SÉCURITÉ, D'INSTALLATION, D'UTILISATION ET D'ENTRETIEN

Nous ne sommes pas responsables des blessures ou des dommages résultant du non-respect de nos conseils/instructions de sécurité, d'installation, d'utilisation et d'entretien.

3.2 ACIER CORTEN

Les OFYR® Kamado Table Corten 65 PRO et 135 PRO sont fabriquées en acier Corten, un acier avec une corrosion superficielle volontaire, qui offre une grande protection contre la corrosion et est conçue pour résister à toutes les conditions météorologiques. Lors de la livraison de votre OFYR® Kamado Table Corten 65 PRO et 135 PRO, le processus de corrosion a déjà démarré. Il faudra encore 6 à 12 mois pour que la corrosion initiale devienne une couche de protection complète.

-  La couleur de l'unité de cuisson peut varier avec le temps étant donné que le processus de corrosion n'est pas encore terminé. Nous ne sommes pas responsables du changement de couleur.
-  Tous les éléments en acier Corten qui sont moins corrodés que les autres à la livraison ne peuvent pas prétendre à un remplacement. Tous les composants se corroderont naturellement avec le temps et l'influence des éléments extérieurs. Nous ne sommes pas responsables des différences de corrosion entre les différents éléments.
-  Tant que la corrosion est superficielle, les éléments en acier Corten peuvent entraîner des taches oranges sur les vêtements, sur la peau et toute surface sur laquelle ils reposent. En cas de pluie, l'eau corrosive peut également s'écouler de ces éléments, ce qui provoquerait des taches permanentes sur les surfaces en pierre claire ou en bois. Nous ne sommes pas responsables des taches résultant de la corrosion. Tant que la corrosion est superficielle, les éléments en acier Corten peuvent entraîner des taches oranges sur les vêtements, sur la peau et toute surface sur laquelle ils reposent. En cas de pluie, l'eau corrosive peut également s'écouler de ces éléments, ce qui provoquerait des taches permanentes sur les surfaces en pierre claire ou en bois. Nous ne sommes pas responsables des taches résultant de la corrosion.

3.3 ACIER LAQUÉ NOIR

-  Notez que les OFYR® Kamado Table Black PRO sont dotées d'un revêtement spécifique et sont donc plus sensibles aux dommages lors de l'installation et de l'utilisation. Nous ne sommes pas responsables des dommages résultant de l'installation ou de l'utilisation de votre unité de cuisson OFYR® Kamado Tables Black PRO. Pour les petites réparations, les OFYR® Kamado Tables Black PRO sont livrées, à titre gracieux, avec une bouteille de vernis de réparation.

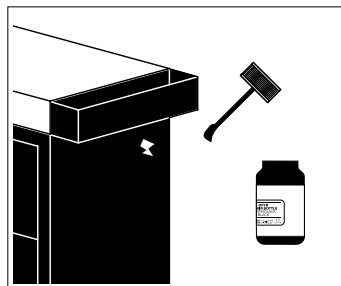

-  Le laquage noir peut se décolorer en raison des conditions climatiques et de la lumière du soleil. Nous ne sommes pas responsables de cette décoloration.

4. CONDITIONS DE GARANTIE PAR ÉLÉMENT

Une garantie limitée dans le temps s'applique au matériel et à la construction de toutes les OFYR® Kamado Table PRO pour les acheteurs ou les propriétaires d'origine. Ils doivent avoir acheté leur unité auprès d'un revendeur agréé et enregistré leur garantie de la manière requise via l'OFYR Club à l'adresse www.ofyr.club.

	B2C	B2B
Éléments en acier corten	5 ans	3 ans
Éléments en acier laqué	2 ans	1 an
Plans de travail en bois	2 ans	1 an
Roues	2 ans	1 an

Cette garantie couvre les défauts de fabrication. Elle s'applique aux acheteurs ou aux propriétaires d'origine des unités de cuisson OFYR® Kamado Table PRO à condition que :

- Ils aient acheté leur unité auprès d'un revendeur agréé ;
- Ils aient assemblé, utilisé et entretenu leur OFYR® Kamado Table PRO conformément aux instructions reprises dans ce manuel.



NE SONT PAS COUVERTS PAR LA GARANTIE

- Usure, corrosion, déformation et décoloration des parties exposées au feu ;
- Corrosion et décoloration causées par des facteurs externes ;
- Irrégularités visuelles inhérentes au processus de fabrication ;
- Dommages causés par le non-respect de nos conseils/instructions en matière de sécurité, d'installation, d'utilisation et d'entretien.

5. PLANS DE TRAVAIL EN BOIS

Tous les plans de travail en bois sont fabriqués en teck. Sa forte teneur en huile, sa résistance à la traction et son grain serré font du teck un matériau particulièrement adéquat lorsqu'il est question de résister aux éléments extérieurs.

5.1 USAGE CONFORME

- Le bois est un produit naturel et il doit donc être stocké à l'intérieur.
- N'utilisez pas les plan de travail en bois comme planches à découper. L'utilisation d'objets tranchants cause des dommages irréversibles.
- N'utilisez pas d'objets lourds, car exercer une grande force sur le plan de travail en bois peut entraîner des dommages irréversibles.

5.2 CONSEILS D'ENTRETIEN

- Avant la première utilisation : Nettoyez soigneusement le plan de travail à l'aide d'un détergent doux.
- Utilisez un linge humide et un détergent doux pour le nettoyage quotidien. Assurez-vous de nettoyer le plan de travail après chaque utilisation.
- Nettoyage des taches tenaces : utilisez un linge humide ou une éponge (pas de tampon à récurer) avec un détergent doux.
- Nettoyez le bois dans le sens des nervures afin de conserver la qualité du matériau.
- Séchez le plan de travail après l'avoir nettoyé.
- Tous les plans de travail en bois de teck ont été traités avec de l'huile végétale afin de les protéger de la poussière et de l'humidité. Nous recommandons aux utilisateurs de ces plans de travail de les traiter également une fois par an avec de l'huile végétale, voire même plus souvent en cas d'usage fréquent.



Ne nettoyez pas les plans de travail en bois avec des substances corrosives et ne les mettez pas dans le lave-vaisselle.



Les Kamado Tables doivent être stockées à l'intérieur, dans un endroit sec et peu humide. De grandes différences de températures ainsi que l'humidité peuvent entraîner des déformations du bois.

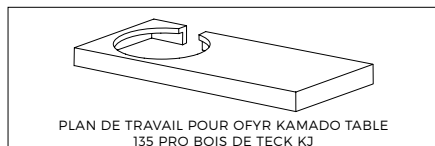

6. PLANS DE TRAVAIL EN BÉTON

Les blocs de béton sont coulés et recouverts de cire. Le béton est assez poreux, ce qui permet à la saleté de pénétrer. La couche de cire l'empêche dans une large mesure. Le béton peut rester en permanence à l'extérieur.

6.1 USAGE CONFORME

- Le béton est résistante aux éléments extérieurs et peut rester à l'extérieur tout au long de l'année.
- Nous vous recommandons l'utilisation d'une planche à découper afin d'éviter d'émousser vos couteaux.
- Le béton peut être nettoyé avec de l'eau tiède et un détergent doux.
- Ne montez jamais sur le plan de travail concret.

6.2 CONSEILS D'ENTRETIEN

- Avant la première utilisation : Le béton peut être nettoyé avec de l'eau tiède et un détergent doux.
- Utilisez un linge humide et un détergent doux pour le nettoyage quotidien. Assurez-vous de nettoyer le plan de travail après chaque utilisation.
- La couche de cire peut se dessécher et doit être renouvelée afin d'empêcher la saleté de pénétrer.



7. INSTRUCTIONS D'INSTALLATION

7.1 OFYR® KAMADO TABLE 65 PRO

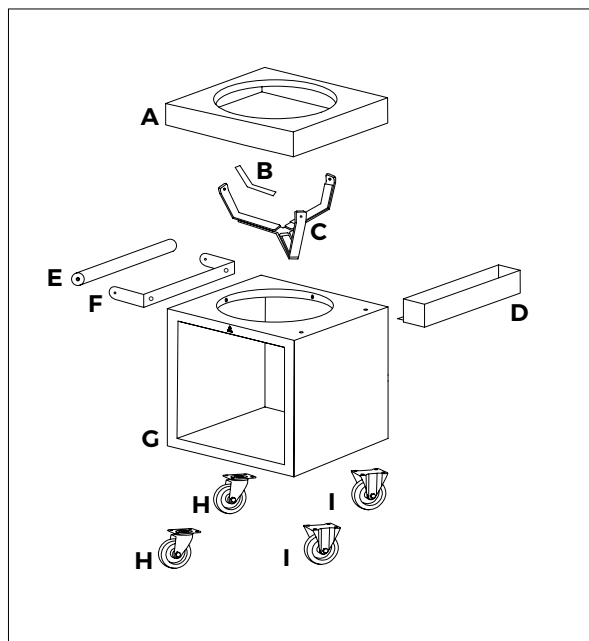

LISTE DES PIECES

- A. Plan de travail en bois
- B. Feutre (3x)
- C. Niche
- D. Bac de rangement
- E. Élément en bois de la poignée
- F. Élément en métal de la poignée
- G. Socle
- H. Roues pivotantes
- I. Roues fixes

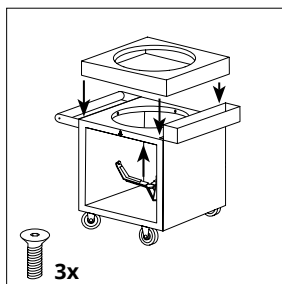
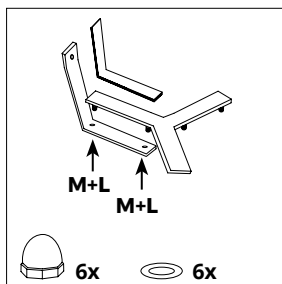
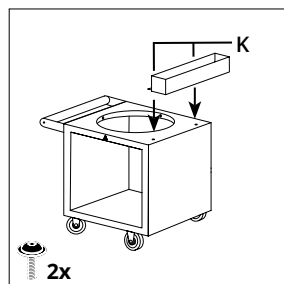
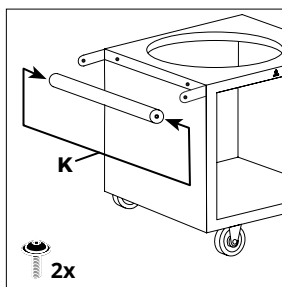
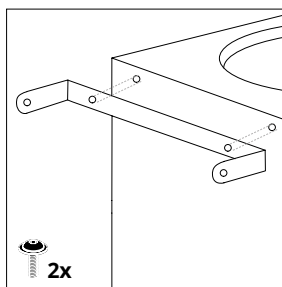
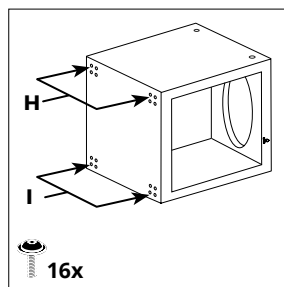
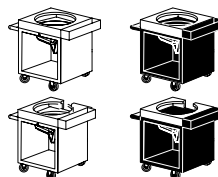
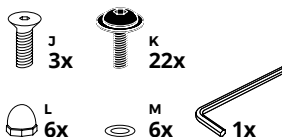

7. INSTRUCTIONS D'INSTALLATION

7.2 OFYR® KAMADO TABLE 135 PRO

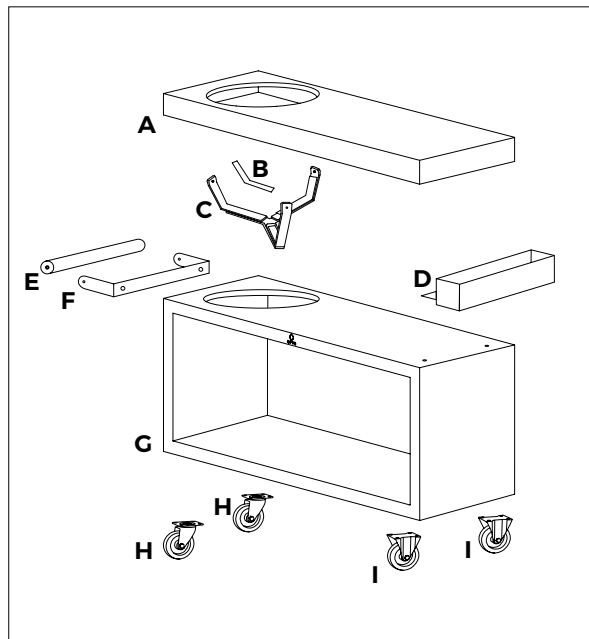

LISTE DES PIECES

- A. Plan de travail en bois
- B. Feutre (3x)
- C. Niche
- D. Bac de rangement
- E. Élément en bois de la poignée
- F. Élément en métal de la poignée
- G. Socle
- H. Roues pivotantes
- I. Roues fixes

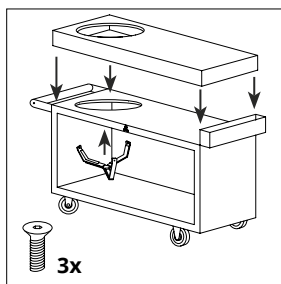
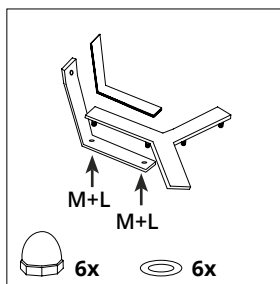
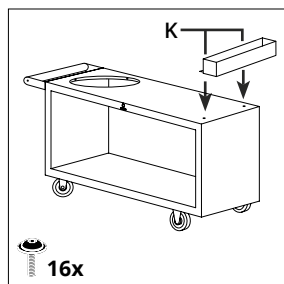
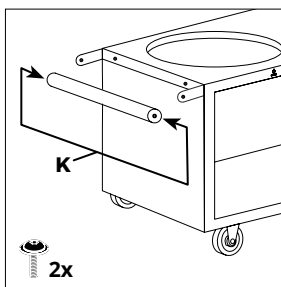
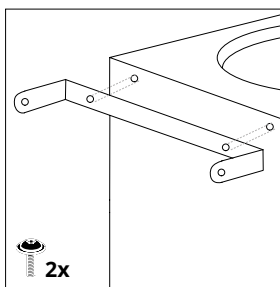
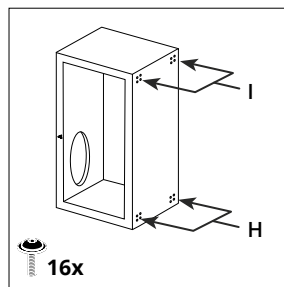
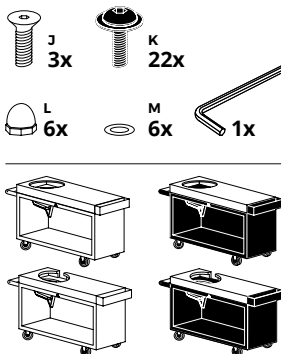

INHOUDSOPGAVE

1. INLEIDING	29
1.1 OFYR® Kamado Table 65 PRO and 135 PRO, onderdelen en beoogd gebruik	29
2. VEILIGHEIDS- EN INSTALLATIEVOORSCHRIFTEN	30
3. DISCLAIMERS	30
3.1 Veiligheids-, installatie-, gebruiks- en onderhoudsvorschriften/tips	30
3.2 Cortenstaal	31
3.3 Zwart gecoat staal	31
4. GARANTIEVOORWAARDEN PER ELEMENT	31
5. HOUTEN BLOKKEN	32
5.1 Beoogd gebruik	32
5.2 Onderhoudstips	32
6. BETONBLOKKEN	33
6.1 Beoogd gebruik	33
6.2 Onderhoudstips	33
7. MONTAGE-INSTRUCTIES	34
7.1 OFYR® Kamado Table 65 PRO	34
7.2 OFYR® Kamado Table 135 PRO	35

SYMBOLLEN EN PICTOGRAMMEN



Gevaar! Risico op ernstig of dodelijk letsel of ernstige schade aan het product



Waarschuwing! Risico op letsel of schade aan het product.



Opmerking! Nuttige informatie.

1. INLEIDING

BEDANKT VOOR DE AANKOOP VAN EEN OFYR®-PRODUCT. DEZE HANDLEIDING BEVAT DE INSTALLATIEINSTRUCTIES, DE GARANTIEVOORWAARDEN EN BIJKOMENDE INFORMATIE OVER UW OFYR KAMADO TABLE 65 PRO EN 135 PRO.

1.1 OFYR® KAMADO TABLE 65 PRO EN 135 PRO, ONDERDELEN EN BEOOGD GEBRUIK

Deze is uitgerust met een handvat, 2 zwenkwielen (aan de zijde van het handvat) en 2 vaste wielen. De OFYR® Mise en Place Table 65 PRO en 135 PRO bevat eveneens een snijblok in Teakhout of donkergrijs beton waarop voedsel voorbereid kan worden, alsook een handige houder voor accessoires en optioneel een opslagruimte voor hout onder het werkblad. De snijplank bevat een groot gat met daaronder een “nest” waarin zowel een Big Green Egg Large als een Kamado Joe Classic II past.

Het werkblad voor de Kamado Joe Classic II heeft aan de achterkant een inkeping waarin het scharnier van de Kamado Joe Classic II past. De bodem van het nest is bedekt met vilt voor warmte-isolatie. Het teakhouten bord moet met de hand gereinigd worden en mag niet behandeld worden met bijtend schoonmaakmiddel. Na het schoonmaken dient de tafel binnen in een droge ruimte met een lage luchtvochtigheid opgeslagen te worden. Hoge temperatuur verschillen en vochtigheid kunnen het hout doen kromtrekken.

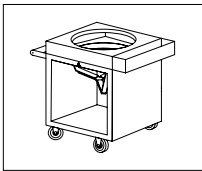

OFYR® KAMADO TABLE
CORTEN 65 PRO TEAKHOUT
BGE

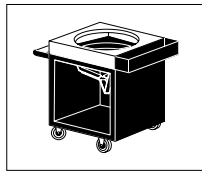

OFYR® KAMADO TABLE
BLACK 65 PRO TEAKHOUT
BGE

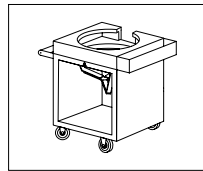

OFYR® KAMADO TABLE
CORTEN 65 PRO TEAKHOUT
KJ

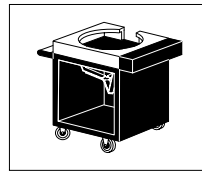

OFYR® KAMADO TABLE
BLACK 65 PRO TEAKHOUT
KJ

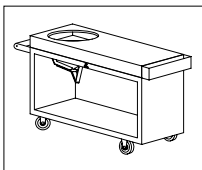

OFYR® KAMADO TABLE
CORTEN 135 PRO TEAKHOUT
BGE

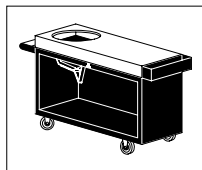

OFYR® KAMADO TABLE
BLACK 135 PRO TEAKHOUT
BGE

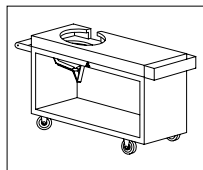

OFYR® KAMADO TABLE
CORTEN 135 PRO
TEAKHOUT KJ

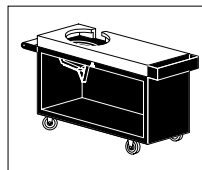

OFYR® KAMADO TABLE
BLACK 135 PRO TEAKHOUT
KJ



OFYR® KAMADO TABLE
CORTEN 65 PRO BETON
BGE

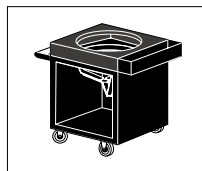

OFYR® KAMADO TABLE
BLACK 65 PRO BETON
BGE

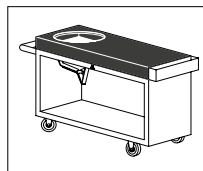

OFYR® KAMADO TABLE
CORTEN 135 PRO BETON
BGE

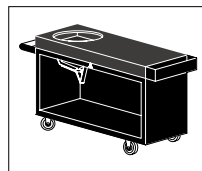

OFYR® KAMADO TABLE
BLACK 135 PRO
BETON BGE

2. VEILIGHEIDS- EN INSTALLATIEVOORSCHRIFTEN



Gezien het aanzienlijk gewicht van de onderdelen, dient het uitpakken en de installatie van het product door ten minste 2 personen te gebeuren.



Omdat de corrosie nog steeds oppervlakkig is, kunnen de onderdelen in Cortenstaal oranje vlekken veroorzaken op kleding, huid en het oppervlak waarop ze staan. Bij regen, kan er ook roestwater van deze onderdelen aflopen, en permanente vlekken veroorzaken op licht getinte stenen of houten oppervlakken.



Maak geen gebruik van het handvat om de sokkel te kantelen bij het plaatsen van de onderdelen van je OFYR® Kamado Table PRO. Het handvat is alleen geschikt om het toestel te trekken of te duwen nadat de wielen zijn gemonteerd.



De OFYR® Kamado Table Black 65 PRO en 135 PRO Black zijn door hun coating gevoeliger voor beschadiging tijdens de installatie en het gebruik.



De OFYR® Kamado Table PRO dient uitsluitend op een hard, waterpas, hittebestendig en stabiel oppervlak geplaatst te worden.



De wielen van uw OFYR® Kamado Table PRO zijn niet uitgerust met remmen. Als het oppervlak niet volledig waterpas is, dienen er wiggen onder de wielen te worden geplaatst om er zeker van te zijn dat het toestel niet kan bewegen.



Laat uw OFYR® Kamado Table PRO tijdens het gebruik nooit onbeheerd achter.



Houd kinderen en huisdieren uit de buurt van de Kamado Table PRO tijdens het gebruik.



Gebruik de OFYR® Kamado Table PRO nooit binnenshuis of in een gedeeltelijk of volledig afgesloten ruimte. Dit kan een teveel aan gevaarlijke dampen genereren die kunnen leiden tot koolmonoxidevergiftiging.



Zorg er voor dat er in de buurt van je OFYR® Kamado Table PRO geen brandbare materialen zijn.



Berg de Kamado Table PRO altijd binnen in een droge ruimte met een lage luchtvochtigheid op. Hout is namelijk een natuurlijk product en kan om die reden altijd kromtrekken.

3. DISCLAIMERS

3.1 VEILIGHEIDS-, INSTALLATIE-, GEBRUIKS- EN ONDERHOUDSVOORSCHRIFTEN/TIPS

Wij zijn niet aansprakelijk voor enig letsel of schade als gevolg van het niet opvolgen van onze veiligheids-, installatie-, gebruiks- en onderhoudsvoorschriften/tips.

3.2 CORTENSTAAL

De OFYR® Kamado Table Corten 65 PRO and 135 PRO zijn gemaakt uit Cortenstaal: een metaal met een natuurlijke corrosielaag die beschermt tegen roestperforatie. De OFYR Kamado Tables Corten worden zo geleverd dat het corrosieproces al begonnen is. Na levering duurt het nog 6 tot 12 maanden voordat de oorspronkelijke corrosie omgezet wordt in een volledig beschermende laag.



De kleur van het toestel kan in de loop van de tijd wijzigen omdat het corrosieproces mogelijk nog niet volledig is afgelopen. Wij zijn niet aansprakelijk voor dergelijke verkleuring.



Onderdelen in Cortenstaal die bij levering minder gecorrodeerd zijn dan andere, komen niet in aanmerking voor vervanging. Alle onderdelen zullen na verloop van tijd op natuurlijke wijze corrodere onder invloed van het weer. Wij zijn niet aansprakelijk voor eventuele verschillen in corrosie tussen de verschillende onderdelen.



Hoewel de corrosie oppervlakkig is, kunnen de onderdelen in Cortenstaal oranje vlekken veroorzaken op kleding, huid en het oppervlak waarop ze staan. Bij regen, kan er ook roestwater van deze onderdelen afvloeien, wat permanente vlekken kan veroorzaken op licht getinte stenen of houten oppervlakken. Wij zijn niet aansprakelijk voor vlekken als gevolg van corrosie.

3.3 ZWART GEOCOAT STAAL



Houd er rekening mee dat de OFYR® Kamado Tables Black PRO een coating heeft endaarvoor gevoeliger is voor beschadiging tijdens installatie en gebruik. Wij zijn niet aansprakelijk voor enige gevolgschade als gevolg van de installatie of het gebruik van uw OFYR® Kamado Table Black 65 PRO en Black 135 PRO. Voor kleine reparaties aan de OFYR® Kamado Tables Black PRO kunt u het meegeleverde reparatieflesje gebruiken.

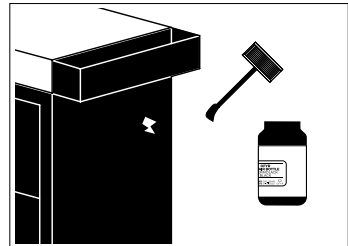

Door weersinvloeden en zonlicht kan de coating verkleuren. Wij zijn niet aansprakelijk voor dergelijke verkleuring.

4. GARANTIEVOORWAARDEN PER ELEMENT

Er geldt een beperkte tijdsgebonden garantie op het materiaal en de constructie van alle OFYR® Kamado Tables PRO voor de oorspronkelijke kopers of eigenaars, op voorwaarde dat ze hun kooktoestel bij een erkende dealer hebben gekocht en hun garantie op de vereiste manier hebben geregistreerd via de OFYR Club op www.ofyr.club.

	B2C	B2B
Cortenstalen delen	5 jaar	3 jaar
Stalen gecoate delen	2 jaar	1 jaar
Houten blokken	2 jaar	1 jaar
Wielen	2 jaar	1 jaar

Deze garantie dekt fabricagefouten. Ze is van toepassing op de oorspronkelijke kopers of eigenaars van een OFYR® Kamado Table PRO, op voorwaarde dat:

- Ze hun toestel gekocht hebben bij een erkende dealer
- Ze de OFYR® Kamado Table PRO gemonteerd, gebruikt en onderhouden hebben volgens de instructies in deze handleiding.



NIET GEDEKT DOOR GARANTIE

- Slijtage, corrosie, vervorming en verkleuring van aan vuur blootgestelde onderdelen;
- Corrosie en verkleuring veroorzaakt door invloeden van buitenaf;
- Visuele onregelmatigheden die inherent zijn aan het fabricageproces;
- Schade veroorzaakt door het niet opvolgen van onze veiligheids-, installatie-, gebruiks- en onderhoudsinstructies/tips.

5. HOUTEN BLOKKEN

Alle houten blokken zijn gemaakt van Teakhout. Het hoge oliegehalte, de hoge treksterkte en de strakke korrel van Teakhout maken het bijzonder geschikt waar weersbestendigheid gewenst is.

5.1 BEOOGD GEBRUIK

- Hout is een natuurlijk product en moet daarom binnenshuis worden opgeslagen.
- Gebruik de houten blokken niet als snijplank. Het gebruik van scherpe voorwerpen veroorzaakt onherstelbare schade.
- Gebruik geen zware voorwerpen, omdat de grote last die wordt uitgeoefend op het houten blok onherstelbare schade kan veroorzaken.

5.2 ONDERHOUDSTIPS

- Voor het eerste gebruik: reinig het werkblad grondig met een mild schoonmaakmiddel.
- Gebruik voor de dagelijkse reiniging een vochtige doek en een mild reinigingsmiddel. Zorg ervoor dat je het blok na elk gebruik schoonmaakt.
- Reiniging van hardnekkige vlekken: gebruik een vochtige doek of een spons (geen schuursponsje) samen met een mild schoonmaakmiddel.
- Reinig het hout in de richting van de nerf om de kwaliteit van het materiaal te behouden.
- Droog het blok na het reinigen.
- Alle teakhouten blokken zijn behandeld met plantaardige olie om ze te beschermen tegen vuil en vocht. Wij raden de gebruikers van deze producten ook aan om deze blokken minimaal één keer per jaar met dergelijke olie te behandelen. Indien nodig vaker, bij veelvuldig gebruik.



Reinig de houten blokken niet met bijtende stoffen en reinig ze niet in de vaatwasser.



De Kamado Tables moet binnen worden opgeslagen, op een droge plaats met een lage luchtvochtigheid. Door grote temperatuurverschillen en vochtigheid kan het hout kromtrekken.

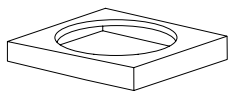

BLOCK FOR OFYR KAMADO TABLE
65 PRO TEAKHOUT BGE

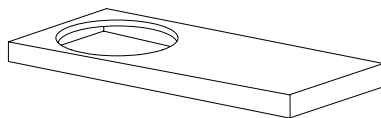

BLOCK FOR OFYR KAMADO TABLE
135 PRO TEAKHOUT BGE

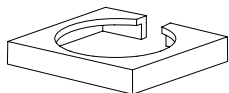

BLOCK FOR OFYR KAMADO TABLE
65 PRO TEAKHOUT KJ

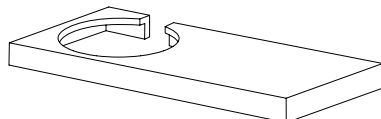

BLOCK FOR OFYR KAMADO TABLE
135 PRO TEAKHOUT KJ

6. BETONBLOKKEN

De betonblokken zijn gegoten en met was gecoat. Beton is vrij poreus, waardoor vuil kan doordringen. De waslaag voorkomt dit in grote mate. Het beton kan permanent buiten blijven.

6.1 BEOOGD GEBRUIK

- Beton is weerbestendig en kan permanent buiten worden opgeslagen.
- We raden ook aan om een snijplank te gebruiken, om te voorkomen dat uw messen bot worden.
- Het beton kan worden gereinigd met lauwwarm water en een mild reinigingsmiddel.
- Ga nooit op het beton blok staan.

6.2 ONDERHOUDSTIPS

- Voor het eerste gebruik: maak de plank schoon met lauwwarm water en een mild schoonmaakmiddel.
- Gebruik voor de dagelijkse reiniging een vochtige doek met een mild reinigingsmiddel. Zorg ervoor dat u het blok na elk gebruik schoonmaakt.
- De waslaag kan uitdrogen en moet worden vernieuwd om te voorkomen dat er vuil binnendringt.



BLOCK FOR OFYR KAMADO TABLE
65 PRO BETONBLOKKEN BGE

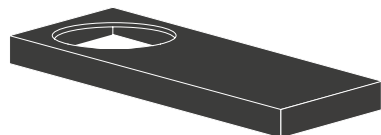

BLOCK FOR OFYR KAMADO TABLE
135 PRO BETONBLOKKEN BGE

7. MONTAGE-INSTRUCTIES

7.1 OFYR® KAMADO TABLE 65 PRO

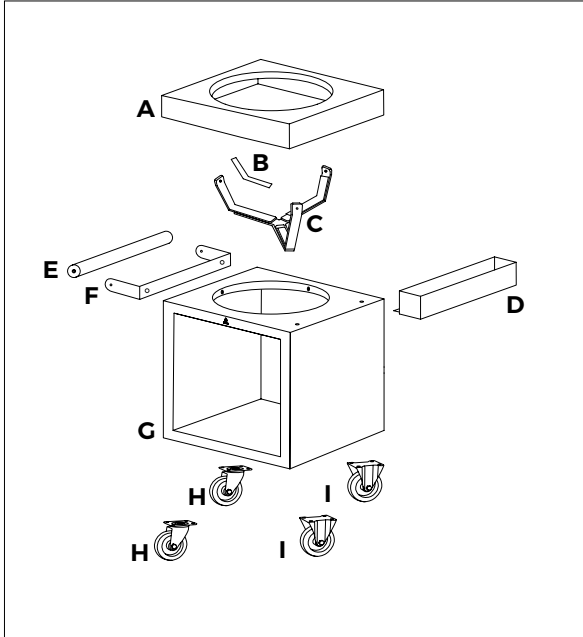

ONDERDELENLIJST

- A. Houten blok
- B. Vilt (3x)
- C. Nest
- D. Tooltray
- E. Houten gedeelte van het handvat
- F. Metalen onderdeel van het handvat
- G. Sokkel
- H. Zwenkwielen
- I. Vaste wielen

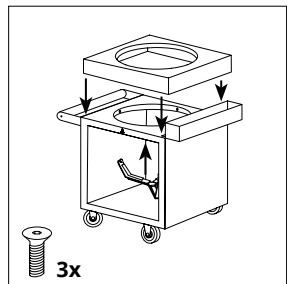
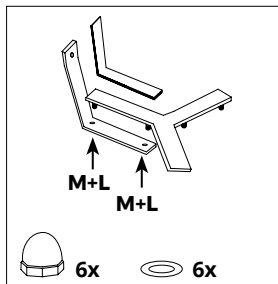
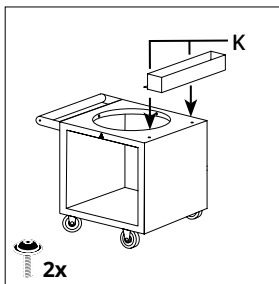
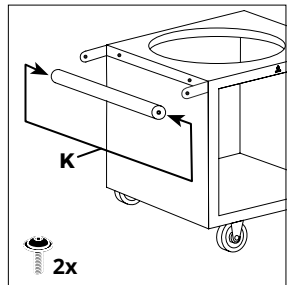
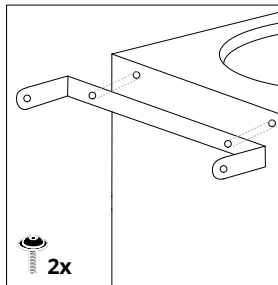
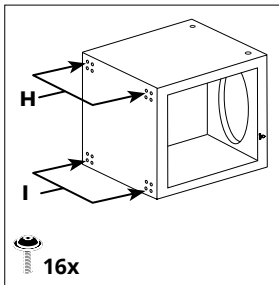
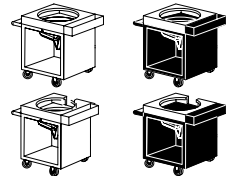
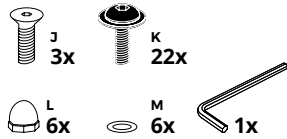

7. MONTAGE-INSTRUCTIES

7.2 OFYR® KAMADO TABLE 135 PRO

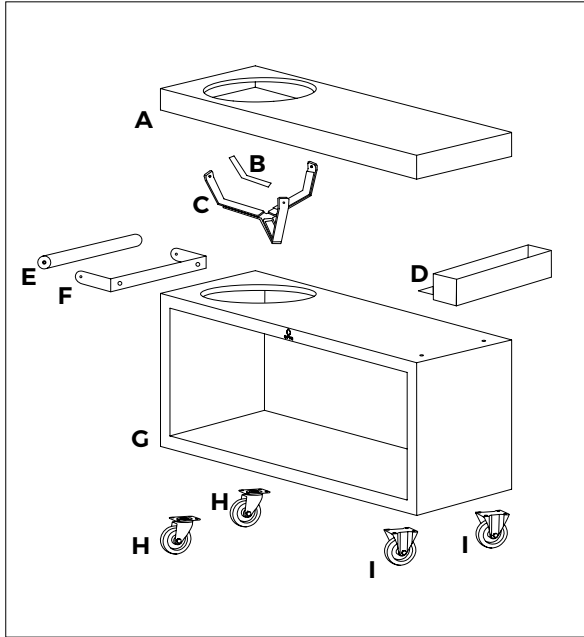

ONDERDELENLIJST

- A. Houten blok
- B. Vilt (3x)
- C. Nest
- D. Tooltray
- E. Houten gedeelte van het handvat
- F. Metalen onderdeel van het handvat
- G. Sokkel
- H. Zwenkwielen
- I. Vaste wielen

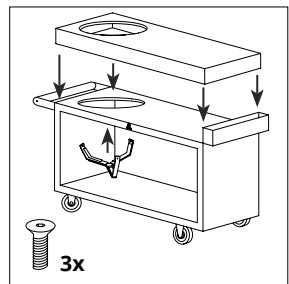
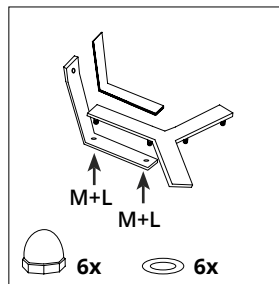
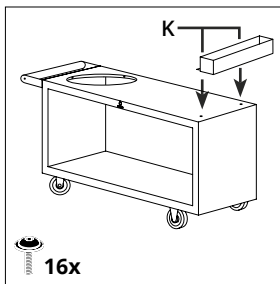
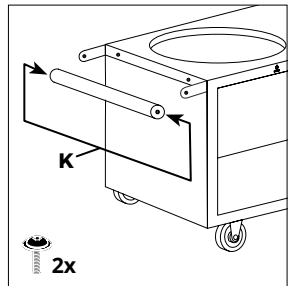
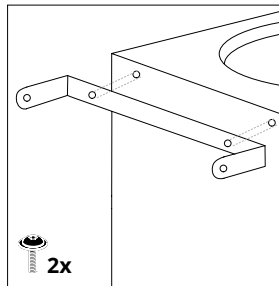
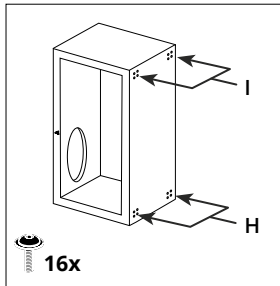
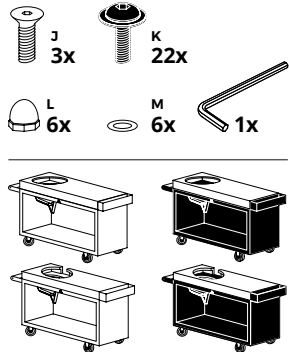

ÍNDICE

1. INTRODUCCIÓN	37
1.1 OFYR® Kamado Table 65 PRO y 135 PRO, partes y uso previsto	37
2. SEGURIDAD E INSTRUCCIONES DE MONTAJE	38
3. DESCARGOS DE RESPONSABILIDAD	38
3.1 Instrucciones y consejos de seguridad, de uso previsto y de mantenimiento	38
3.2 Acero corten	39
3.3 Acero lacado en negro	39
4. CONDICIONES DE GARANTÍA POR ELEMENTO	39
5. BLOQUES DE MADERA	40
5.1 Uso previsto	40
5.2 Consejos de mantenimiento	40
6. BLOQUES DE CONCRETO	41
6.1 Uso previsto	41
6.2 Consejos de mantenimiento	41
7. INSTRUCCIONES DE MONTAJE	42
7.1 OFYR® Kamado Table 65 PRO	42
7.2 OFYR® Kamado Table 135 PRO	43

SÍMBOLOS E ICONOS



Peligro! Riesgo de lesiones graves o mortales o de daños graves en el producto.



¡Advertencia! Riesgo de lesiones o daños en el producto



¡Aviso! Información útil.

1. INTRODUCCIÓN

MUCHAS GRACIAS POR HABER COMPRADO UN PRODUCTO OFYR®. ESTE MANUAL CONTIENE INSTRUCCIONES DE CONFIGURACIÓN, CONDICIONES DE GARANTÍA E INFORMACIÓN ADICIONAL SOBRE SU OFYR KAMADO TABLE 65 PRO Y 135 PRO.

1.1 OFYR® KAMADO TABLE 65 PRO Y 135 PRO, PARTES Y USO PREVISTO

Equipadas con un asa, 2 ruedas pivotantes (por el lado del asa) y 2 ruedas fijas. OFYR® Kamado Table 65 PRO y 135 PRO incluye además una tabla de cortar de madera de teca o concreto de color gris oscuro para la preparación de alimentos, así como una práctica bandeja de accesorios. La tabla de cortar contiene un gran hoyo con un “nido” debajo en lo que se puede colocar un Big Green Egg Large o un Kamado Joe Classic II.

La tabla de cortar para el Kamado Joe Classic II tiene además en la parte trasera un corte en el que encaja la bisagra del Kamado Joe Classic II. La parte inferior del nido está cubierta con fieltro por razones de aislamiento de calor. mano y no debe ser tratada con cualquier sustancia corrosiva. Después de limpiarla, debe guardar la mesa en el interior, en un lugar seco con poca humedad. Las grandes diferencias de temperatura y humedad pueden hacer que la madera se deforme.

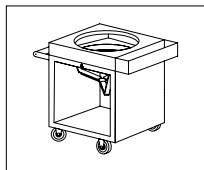

OFYR® KAMADO TABLE
CORTEN 65 PRO MADERA
DE TECA BGE



OFYR® KAMADO TABLE
BLACK 65 PRO MADERA DE
TECA BGE

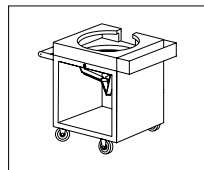

OFYR® KAMADO TABLE
CORTEN 65 PRO MADERA
DE TECA KJ

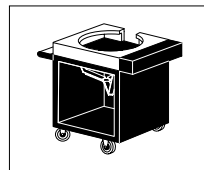

OFYR® KAMADO TABLE
BLACK 65 PRO MADERA DE
TECA KJ

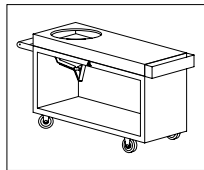

OFYR® KAMADO TABLE
CORTEN 135 PRO MADERA
DE TECA BGE

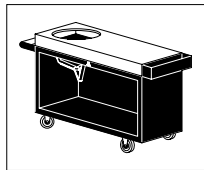

OFYR® KAMADO TABLE
BLACK 135 PRO MADERA DE
TECA BGE

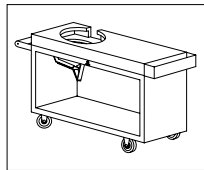

OFYR® KAMADO TABLE
CORTEN 135 PRO MADERA
DE TECA KJ

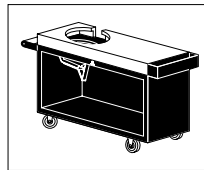

OFYR® KAMADO TABLE
BLACK 135 PRO MADERA DE
TECA KJ

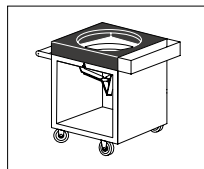

OFYR® KAMADO TABLE
CORTEN 65 PRO CONCRETO
BGE

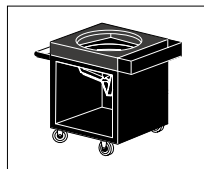

OFYR® KAMADO TABLE
BLACK 65 PRO CONCRETO
BGE

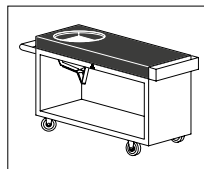

OFYR® KAMADO TABLE
CORTEN 135 PRO
CONCRETO BGE

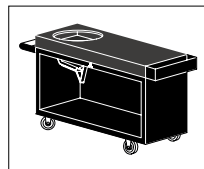

OFYR® KAMADO TABLE
BLACK 135 PRO
CONCRETO BGE

2. SEGURIDAD E INSTRUCCIONES DE MONTAJE



Debido al considerable peso de los elementos, deberán participar al menos 2 personas en el desembalaje y la colocación del producto.



Aunque la corrosión es superficial, los elementos de acero corten pueden ocasionar manchas anaranjadas en la ropa, la piel y la superficie sobre la que se encuentren. Bajo la lluvia, también es posible que salga agua corrosiva de estos elementos, la cual puede manchar permanentemente superficies de piedra o madera de tono claro.



Al montar las piezas de su OFYR® Kamado Table PRO, no utilice el asa para inclinar la base. El asa solamente sirve para desplazar el aparato una vez que se hayan montado las ruedas.



Las OFYR® Kamado Table Black 65 PRO y 135 PRO negras son más sensibles a los daños durante la instalación, ya que están lacadas.



Coloque su OFYR® Kamado Table PRO únicamente sobre una superficie dura, nivelada, resistente al calor y estable.



Las ruedas de su OFYR® Kamado Table PRO no están equipadas con frenos. Si la superficie no está completamente nivelada, se deben colocar cuñas debajo de las ruedas para asegurarse de que la unidad de cocina permanezca inmóvil.



Nunca deje su OFYR® Kamado Table PRO desatendida durante el uso.



Mantenga a los niños y a los animales de compañía alejados de el Kamado Table PRO durante el uso.



Nunca utilice un OFYR® Kamado Table PRO en interiores o en un espacio parcial o totalmente cerrado. Esto ocasiona un exceso de humos peligrosos que pueden producir una intoxicación por monóxido de carbono.



Asegúrese de que no haya ningún material inflamable en la zona de alrededor de OFYR® Kamado Table PRO.



Siempre almacene la Kamado Table PRO en un lugar seco y con poca humedad. Esto porque la madera es un producto natural y siempre es posible que se deforme un poco.

3. DESCARGOS DE RESPONSABILIDAD

3.1 INSTRUCCIONES Y CONSEJOS DE SEGURIDAD, DE USO PREVISTO Y DE MANTENIMIENTO

No nos hacemos responsables de ninguna lesión o daño como consecuencia de no respetar nuestras instrucciones de seguridad y configuración, de uso previsto y de mantenimiento.

3.2 ACERO CORTEN

Las OFYR® Kamado Table Corten 65 PRO y 135 PRO están compuestas de acero corten: un metal con una capa natural de corrosión que protege contra la perforación del óxido. Las OFYR® Kamado Tables Corten ofrecen el servicio adicional de que el proceso de corrosión ya ha comenzado cuando se entregan. Tras la entrega, harán falta otros 6-12 meses para que la corrosión inicial se convierta en una capa totalmente protectora.



El color de la unidad puede cambiar con el tiempo, ya que el proceso de corrosión puede no haberse desarrollado completamente. No somos responsables de ningún cambio de color.



Los componentes de acero corten que estén menos corroídos que otros al ser entregados no pueden ser reemplazados. Todos los componentes se corroerán naturalmente con el tiempo bajo la influencia del clima. No somos responsables de ninguna diferencia de corrosión entre los diferentes elementos



Aunque la corrosión es superficial, los elementos de acero corten pueden ocasionar manchas anaranjadas en la ropa, la piel y la superficie sobre la que se encuentren. Bajo la lluvia, también es posible que salga agua corrosiva de estos elementos, la cual puede manchar permanentemente superficies de piedra o madera de tono claro. No somos responsables de las manchas como consecuencia de la corrosión.

3.3 ACERO LACADO EN NEGRO



Tenga en cuenta que las OFYR® Kamado Tables Black PRO están lacadas, por lo cualson más sensibles a los daños durante el montaje y el uso. No nos hacemos responsables de ningún daño que resulte del montaje o el uso de su OFYR® Kamado Table Black 65 PRO y Black 135 PRO. Para pequeñas modificaciones el OFYR® Kamado Tables Black PRO vienen con una botella de modificación gratuita.

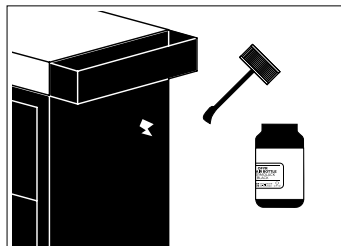

Debido al clima y a la luz solar, el lacado puede exponerse a la decoloración. No somos responsables de dicha decoloración.

4. CONDICIONES DE GARANTÍA POR ELEMENTO

Se aplica una garantía limitada de por vida al material y a la fabricación de todas las OFYR® Kamado Tables PRO para los compradores o propietarios originales, siempre y cuando hayan comprado su unidad a un distribuidor autorizado y hayan registrado su garantía según lo estipulado, a través del Club OFYR en www.ofyr.club.

	B2C	B2B
Elementos de acero corten	5 años	3 años
Elementos de acero corten	2 años	1 año
Bloques de madera	2 años	1 año
Ruedas	2 años	1 año

Esta garantía cubre los defectos de fabricación. Se aplica a los compradores o propietarios originales de un OFYR® Kamado Table PRO siempre que:

- Hayan comprado su unidad a un distribuidor autorizado
- Hayan montado, utilizado y mantenido el OFYR® Kamado Table PRO de acuerdo con las instrucciones de este manual.



NO CUBIERTO POR LA GARANTÍA

- Desgaste, corrosión, deformación y decoloración de las partes expuestas al fuego;
- Corrosión y decoloración causada por influencias externas;
- Irregularidades visuales inherentes al proceso de fabricación;
- Daños causados por no seguir nuestras instrucciones y consejos de seguridad y configuración, uso previsto y mantenimiento.

5. BLOQUES DE MADERA

Todos los bloques de madera están hechos de madera de teca. El alto contenido de aceite de la teca, su alta resistencia a la tensión y su grano de alta densidad la hacen especialmente adecuada cuando se busca resistencia a la intemperie.

5.1 USO PREVISTO

- La madera es un producto natural y por lo tanto debe almacenarse en el interior.
- No utilice las tablas de madera como tablas de cortar. El uso de objetos afilados causa daños irreparables.
- No utilice objetos pesados, ya que al ejercer grandes fuerzas sobre el bloque de madera se pueden causar daños irreparables.

5.2 CONSEJOS DE MANTENIMIENTO

- Antes del primer uso: Limpie la encimera a fondo con un detergente suave.
- Use un paño húmedo y un detergente suave para la limpieza diaria. Asegúrese de limpiar el bloque después de cada uso.
- Limpieza de manchas persistentes: use un paño húmedo o una esponja (sin estropajo) con un detergente suave.
- Limpie la madera en la dirección de los nervios para mantener la calidad del material.
- Seque el bloque después de limpiarlo.
- Todas las tablas de madera de teca se han tratado con aceite vegetal para protegerlas de la suciedad y la humedad. Recomendamos que los usuarios de estos productos también traten estas tablas al menos una vez al año con dicho aceite y más a menudo en caso de uso frecuente.



No limpie las tablas de madera con sustancias corrosivas ni en el lavavajillas.



El bloque de madera debe almacenarse en el interior, en un lugar seco (con escasa humedad). Las grandes diferencias de temperatura y humedad pueden hacer que la madera se deforme.

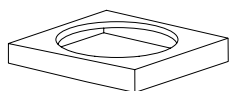

BLOQUE PARA OFYR® KAMADO TABLE 65 PRO
MADERA DE TECA BGE

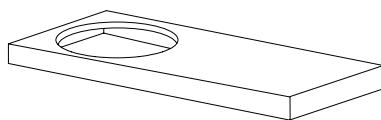

BLOQUE PARA OFYR® KAMADO TABLE 135 PRO
MADERA DE TECA BGE

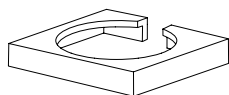

BLOQUE PARA OFYR® KAMADO TABLE 65 PRO
MADERA DE TECA KJ

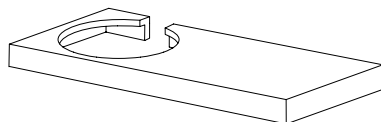

BLOQUE PARA OFYR® KAMADO TABLE 135 PRO
MADERA DE TECA KJ

6. BLOQUES DE CONCRETO

Los bloques de hormigón son fundidos y cubiertos de cera. El hormigón es bastante poroso, permitiendo que la suciedad penetre. La capa de cera evita esto en gran medida. El hormigón puede permanecer en el exterior de forma permanente.

6.1 USO PREVISTO

- La concreto es resistente a la intemperie y puede almacenarse en exteriores de forma permanente.
- Recomendamos utilizar una tabla de cortar para evitar que los cuchillos se desafilan.
- El concreto puede ser limpiado con agua tibia y un detergente suave.
- Nunca se ponga de pie sobre un bloque de concreto.

6.2 CONSEJOS DE MANTENIMIENTO

- Antes de usarla por primera vez, limpia la tabla con agua tibia y un detergente suave.
- Use un paño húmedo con un detergente suave para la limpieza diaria. Asegúrese de limpiar el bloque después de usarlo.
- La capa de cera puede secarse y debe renovarse para evitar que la suciedad penetre.



BLOCK FOR OFYR KAMADO TABLE
65 PRO CONCRETO BGE

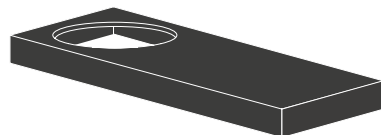

BLOCK FOR OFYR KAMADO TABLE
135 PRO CONCRETO BGE

7. INSTRUCCIONES DE MONTAJE

7.1 OFYR® KAMADO TABLE 65 PRO

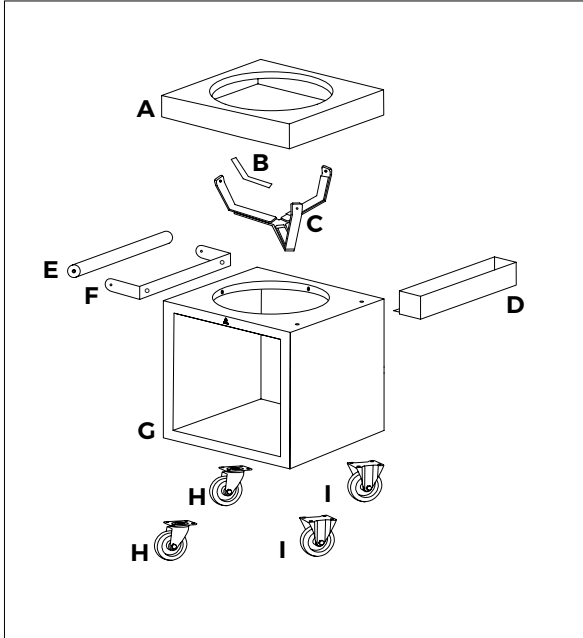

LISTA DE COMPONENTES

- A. Bloque de madera
- B. Fieltro (3x)
- C. Nido
- D. Tooltray
- E. Parte de madera del asa
- F. la parte metálica del asa
- G. Base
- H. Ruedas pivotantes
- I. Ruedas fijas

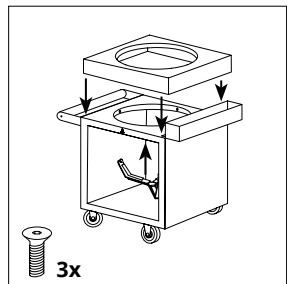
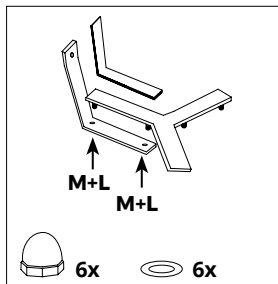
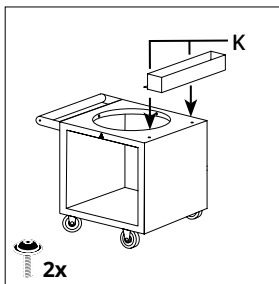
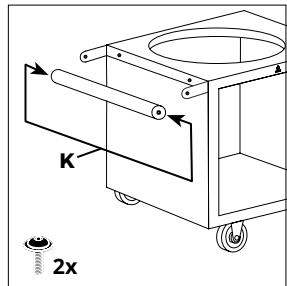
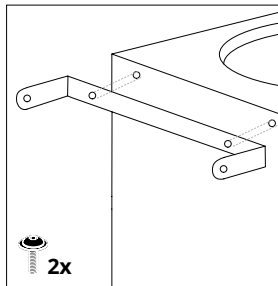
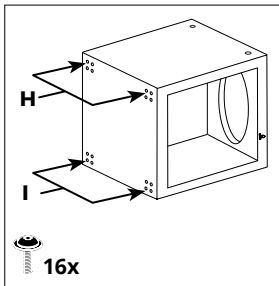
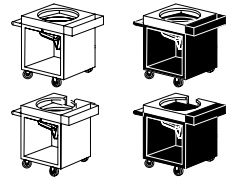
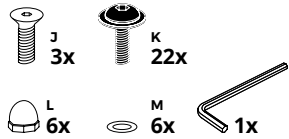

7. INSTRUCCIONES DE MONTAJE

7.2 OFYR® KAMADO TABLE 135 PRO

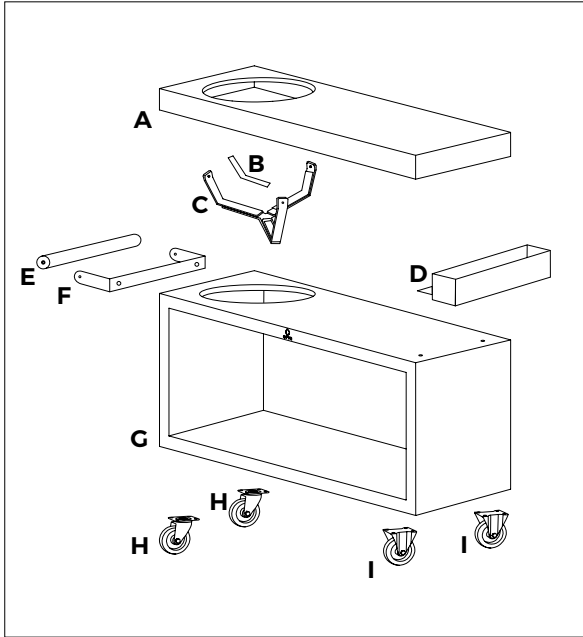

LISTA DE COMPONENTES

- A. Bloque de madera
- B. Fieltro (3x)
- C. Nido
- D. Tooltray
- E. Parte de madera del asa
- F. la parte metálica del asa
- G. Base
- H. Ruedas pivotantes
- I. Ruedas fijas

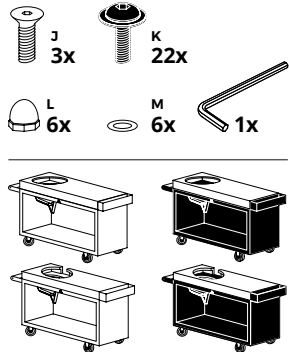

ES



TABELLA DEI CONTENUTI

1. INTRODUZIONE	45
1.1 OFYR® Kamado Table 65 PRO e 135 PRO, parti e destinazione d'uso	45
2. ISTRUZIONI DI SICUREZZA E DI MONTAGGIO	46
3. AVVERTENZE	46
3.1 Istruzioni e suggerimenti per la sicurezza e il montaggio, la destinazione d'uso e la manutenzione	46
3.2 Acciaio Corten	47
3.3 Acciaio con rivestimento nero	47
4. CONDIZIONI DI GARANZIA PER ELEMENTO	47
5. BLOCCHI DI LEGNO	48
5.1 Destinazione d'uso	48
5.2 Suggerimenti per la manutenzione	48
6. BLOCCHI DI CALCESTRUZZO	49
6.1 Destinazione d'uso	49
6.2 Suggerimenti per la manutenzione	49
7. ISTRUZIONI PER IL MONTAGGIO	50
7.1 OFYR® Kamado Table 65 PRO	50
7.2 OFYR® Kamado Table 135 PRO	51

SIMBOLI E ICONE

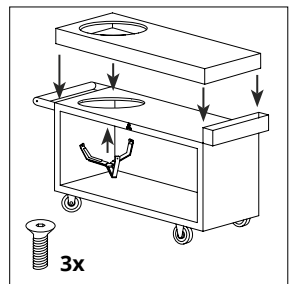
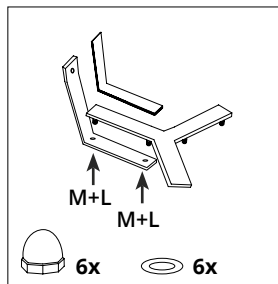
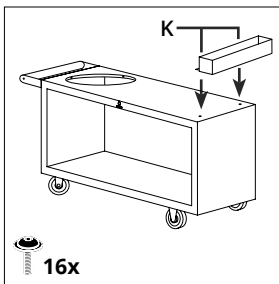
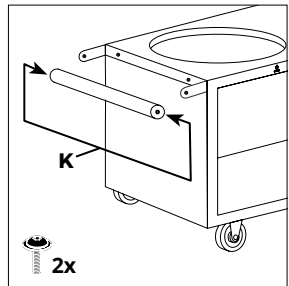
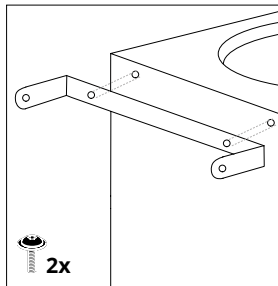
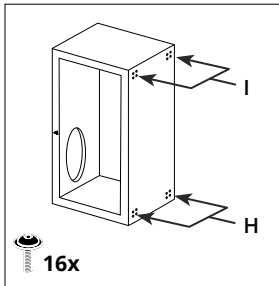

Pericolo! Rischio di lesioni serie o mortali o gravi danni al prodotto.



Attenzione! Rischio di danni al prodotto



Precauzioni! Informazioni utili.

1. INTRODUZIONE

GRAZIE PER AVER ACQUISTATO UN PRODOTTO OFYR®. QUESTO MANUALE CONTIENE ISTRUZIONI PER IL MONTAGGIO, CONDIZIONI DI GARANZIA E ALTRE INFORMAZIONI SULL'OFYR KAMADO TABLE 65 PRO E 135 PRO.

1.1 OFYR® KAMADO TABLE 65 PRO E 135 PRO, PARTI E DESTINAZIONE D'USO

Dotato di una maniglia, 2 ruote girevoli (sul lato della maniglia) e 2 ruote fisse. OFYR® Kamado Table 65 PRO e 135 PRO include inoltre un tagliere in legno Teak o in calcestruzzo grigio scuro per la preparazione degli alimenti e un pratico portaoggetti. Il tagliere contiene un grande foro centrale con sotto un basamento in cui è possibile posizionare un Big Green Egg Large o un Kamado Joe Classic II.

Il tagliere per Kamado Joe Classic II ha inoltre nella parte posteriore un taglio in cui si adatta la cerniera del Kamado Joe Classic II. Il fondo basamento è rivestito di velluto per motivi di isolamento termico. La tavola di legno in teak deve essere pulita a mano e non deve essere trattato con eventuali sostanze corrosive. Dopo averlo pulito, è necessario conservare il tavolo in un luogo asciutto, a bassa umidità. Grandi differenze di temperatura e umidità possono causare la deformazione del legno.

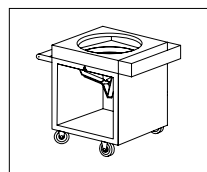

OFYR® KAMADO TABLE
CORTEN 65 PRO LEGNO
TEAK BGE

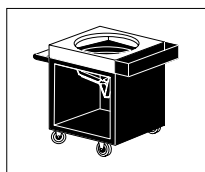

OFYR® KAMADO TABLE
BLACK 65 PRO LEGNO
TEAK BGE

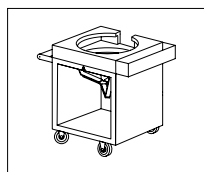

OFYR® KAMADO TABLE
CORTEN 65 PRO LEGNO
TEAK KJ

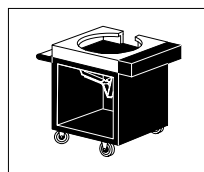

OFYR® KAMADO TABLE
BLACK 65 PRO LEGNO
TEAK KJ

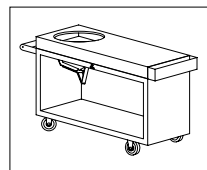

OFYR® KAMADO TABLE
CORTEN 135 PRO LEGNO
TEAK BGE

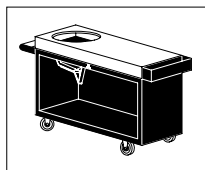

OFYR® KAMADO TABLE
BLACK 135 PRO LEGNO
TEAK BGE

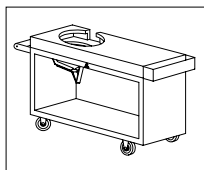

OFYR® KAMADO TABLE
CORTEN 135 PRO LEGNO
TEAK KJ

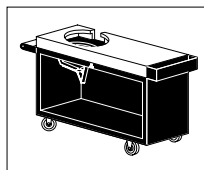

OFYR® KAMADO TABLE
BLACK 135 PRO LEGNO
TEAK KJ

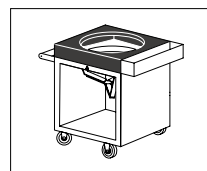

OFYR® KAMADO TABLE
CORTEN 65 PRO
CALCESTRUZZO BGE



OFYR® KAMADO
TABLE BLACK 65 PRO
CALCESTRUZZO BGE

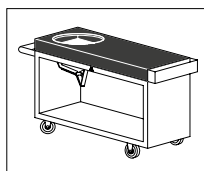

OFYR® KAMADO TABLE
CORTEN 135 PRO
CALCESTRUZZO BGE

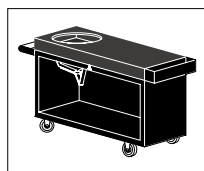

OFYR® KAMADO TABLE
BLACK 135 PRO
CALCESTRUZZO BGE



2. ISTRUZIONI DI SICUREZZA E DI MONTAGGIO



A causa del notevole peso degli elementi, il disimballaggio e il posizionamento del prodotto devono essere eseguiti da almeno 2 persone.



Per evitare danni ai bordi della piastra di cottura in acciaio, fare attenzione durante il trasporto. In caso di danni, la parte superiore non potrà più essere raschiata correttamente con la spatola.



Durante il montaggio dell'OFYR® Kamado Table PRO, non utilizzare la maniglia per inclinare la base. La maniglia è adatta a tirare o spingere l'unità solo dopo aver montato le ruote.



L'OFYR® Kamado Table Black 65 PRO e 135 PRO sono più sensibili ai danni durante il montaggio e l'uso a causa del loro rivestimento.



Posizionare l'OFYR® Kamado Table PRO su una superficie dura, livellata, resistente al calore e stabile.



Le ruote dell'OFYR® Kamado Table PRO non sono dotate di freno. Se la superficie non è completamente piana, devono essere posizionati dei cunei sotto le ruote per evitare che il tavolo si muova.



Non lasciare mai l'OFYR® Kamado Table PRO incustodita durante l'uso.



Tenere lontani bambini e animali domestici dall'Kamado Table PRO durante l'uso.



Non utilizzare mai l'OFYR® Kamado Table PRO all'interno o in uno spazio parzialmente o completamente chiuso. Ciò provocherebbe un eccesso di fumi pericolosi che possono causare avvelenamento da monossido di carbonio.



Assicurarsi che l'area intorno all'OFYR® Kamado Table PRO sia libera da materiali infiammabili.



Conservare sempre Kamado Table PRO al chiuso in un luogo asciutto con bassa umidità. Questo perché il legno è un prodotto naturale ed è sempre soggetto a deformazioni.



3. AVVERTENZE

3.1 ISTRUZIONI E SUGGERIMENTI PER LA SICUREZZA E IL MONTAGGIO, LA DESTINAZIONE D'USO E LA MANUTENZIONE

Non siamo responsabili per eventuali lesioni o danni a seguito della mancata osservanza delle istruzioni/suggerimenti per la sicurezza e il montaggio, la destinazione d'uso e la manutenzione.

3.2 ACCIAIO CORTEN

LOFYR® Kamado Table Corten 65 PRO e 135 PRO sono realizzate in Corten, un acciaio dotato di uno strato naturale di corrosione, che lo protegge dalle perforazioni causate dalla ruggine. Dalla consegna, sono necessari altri 6-12 mesi affinché la corrosione iniziale si trasformi in uno strato completamente protettivo.

-  Il colore del rivestimento potrebbe cambiare nel tempo poiché il processo di corrosione potrebbe non essere ancora completamente terminato. Non siamo responsabili per eventuali variazioni di colore.
-  Eventuali componenti in acciaio Corten che, alla consegna, sono meno corrosivi di altri, non possono essere sostituiti. Tutti i componenti si corroderanno naturalmente nel tempo a causa delle condizioni meteorologiche. Non siamo responsabili per eventuali differenze di corrosione tra gli elementi.
-  Sebbene la corrosione sia ancora superficiale, gli elementi in acciaio Corten possono causare macchie arancioni su vestiti, pelle e superfici su cui si trovano. Quando piove, l'acqua corrosiva potrebbe fuoriuscire da questi elementi, macchiando in modo permanente pietre chiare o superfici in legno. Non siamo responsabili per le macchie causate dalla corrosione.

3.3 ACCIAIO CON RIVESTIMENTO NERO

-  Si noti che l'OFYR® Kamado Tables Black PRO ha un rivestimento ed è quindi più sensibile ai danni durante il montaggio e l'uso. Non siamo responsabili per eventuali danni derivanti dal montaggio o dall'uso. Per le piccole riparazioni, OFYR® Kamado Tables Black PRO sono dotati di una bottiglia di riparazione gratuita.

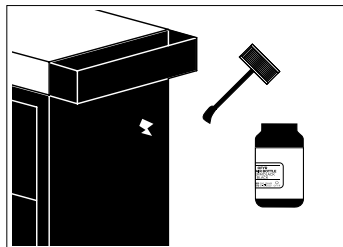

-  A causa delle condizioni atmosferiche e della luce solare il rivestimento potrebbe essere soggetto a scolorimento. Non siamo responsabili per tale scolorimento.

4. CONDIZIONI DI GARANZIA PER ELEMENTO

Una garanzia a vita limitata si applica al materiale e alla costruzione di tutte l'OFYR® Kamado Tables PRO per gli acquirenti o i proprietari originali, a condizione che abbiano acquistato la loro unità da un rivenditore autorizzato e registrato la garanzia nel modo richiesto tramite OFYR Club su www.ofyr.club.

	B2C	B2B
Elementi in acciaio corten	5 anni	3 anni
Elementi in acciaio verniciato	2 anni	1 anno
Blocchi Di Legno	2 anni	1 anno
Ruote	2 anni	1 anno

Questa garanzia copre i difetti di fabbricazione. Si applica agli acquirenti o ai proprietari originali dell'OFYR® Kamado Table PRO a condizione che

- Abbiamo acquistato la loro unità da un rivenditore autorizzato
- Abbiamo assemblato, utilizzato e mantenuto l'OFYR® Kamado Table PRO secondo le istruzioni contenute in questo manuale.



ESCLUSIONI DI GARANZIA

- Usura, corrosione, deformazione e scolorimento delle parti esposte al fuoco;
- Corrosione e scolorimento causati da agenti esterni;
- Irregolarità visive relative al processo di fabbricazione;
- Danni causati dalla mancata osservanza delle nostre istruzioni e suggerimenti per la sicurezza e il montaggio, la destinazione d'uso e la manutenzione.

5. BLOCCHI DI LEGNO

Tutti i blocchi di legno sono realizzati in legno Teak. L'alto contenuto di olio del teak, l'elevata resistenza alla trazione e la grana fitta, lo rendono particolarmente adatto ove sia richiesta resistenza agli agenti atmosferici.

5.1 DESTINAZIONE D'USO

- Il legno è un prodotto naturale e deve quindi essere conservato all'interno.
- Non utilizzare le tavole di legno come tagliere. L'uso di oggetti appuntiti provoca danni irreparabili.
- Non usare oggetti pesanti sul blocco di legno perchè potrebbero causare danni irreparabili.

5.2 SUGGERIMENTI PER LA MANUTENZIONE

- Prima del primo utilizzo: pulire a fondo il piano di lavoro con un detergente delicato.
- Usare un panno umido e un detergente delicato per la pulizia quotidiana. Assicurarsi di pulire il blocco dopo ogni utilizzo.
- Pulizia di macchie persistenti: usare un panno umido o una spugna (no paglietta) con un detergente delicato.
- Pulire il legno nella direzione del nervo per conservare la qualità del materiale.
- Asciugare il blocco dopo la pulizia.
- Tutte le tavole di legno teak sono state trattate con olio vegetale per proteggerle dallo sporco e dall'umidità. Raccomandiamo di trattare anche queste tavole almeno una volta all'anno con tale olio vegetale, o più spesso, in caso di uso frequente.



Non pulire le tavole di legno con sostanze corrosive né in lavastoviglie.



Il Kamado Table deve essere conservato all'interno, in un luogo asciutto, con bassa umidità. Grandi differenze di temperatura e umidità possono causare la deformazione del legno.

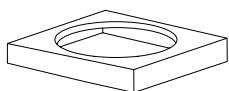

BLOCCO PER OFYR® KAMADO TABLE
65 PRO LEGNO TEAK BGE

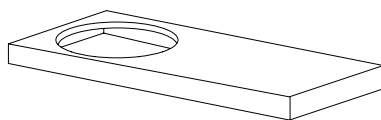

BLOCCO PER OFYR® KAMADO TABLE
135 PRO LEGNO TEAK BGE

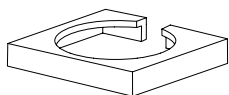

BLOCCO PER OFYR® KAMADO TABLE
65 PRO LEGNO TEAK KJ

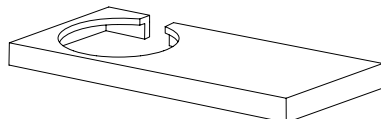

BLOCCO PER OFYR® KAMADO TABLE
135 PRO LEGNO TEAK KJ

6. BLOCCHI DI CALCESTRUZZO

I blocchi di calcestruzzo sono fusi e rivestiti di cera. Il calcestruzzo è abbastanza poroso, permettendo allo sporco di penetrare. Lo strato di cera lo impedisce in gran parte. Il calcestruzzo può rimanere all'esterno in modo permanente.

6.1 DESTINAZIONE D'USO

- La calcestruzzo è resistente alle intemperie e può essere conservata all'aperto su base permanente.
 - Consigliamo di utilizzare un tagliere per evitare che i coltelli si smussino.
 - Il calcestruzzo può essere pulito con acqua tiepida e un detergente delicato.
 - Non salire mai sul blocco di calcestruzzo.
-

6.2 SUGGERIMENTI PER LA MANUTENZIONE

- Prima del primo utilizzo: pulire la tavola con acqua tiepida e un detergente delicato.
 - Per la pulizia quotidiana utilizzare un panno umido con un detergente delicato. Assicurarsi di pulire il blocco dopo l'uso.
 - Lo strato di cera può asciugarsi e deve essere rinnovato per evitare che lo sporco penetri.
-



BLOCK FOR OFYR KAMADO TABLE
65 PRO CALCESTRUZZO BGE

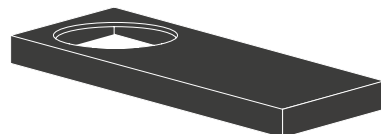

BLOCK FOR OFYR KAMADO TABLE
135 PRO CALCESTRUZZO BGE

7. ISTRUZIONI PER IL MONTAGGIO

7.1 OFYR® KAMADO TABLE 65 PRO

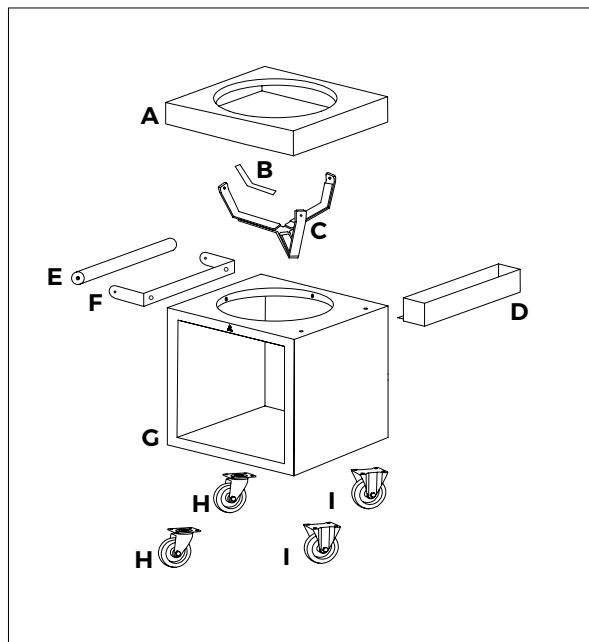

ELENCO DEI COMPONENTI

- A. Blocco di legno
- B. Feltro (3x)
- C. basamento
- D. Tooltray
- E. Parte in legno dell'impugnatura
- F. Parte metallica dell'impugnatura
- G. Base
- H. Ruote girevoli
- I. Ruote fisse

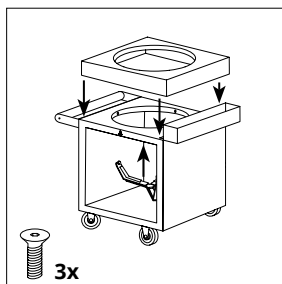
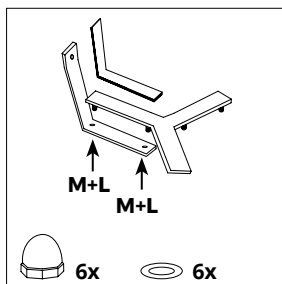
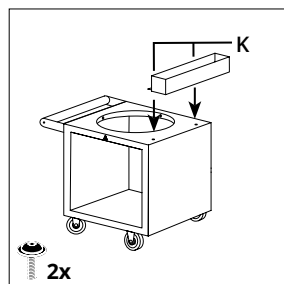
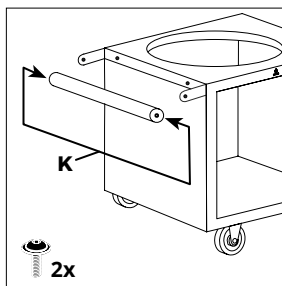
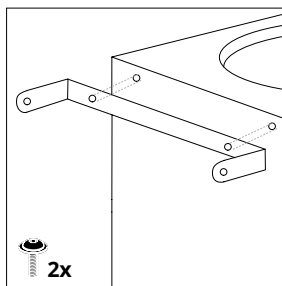
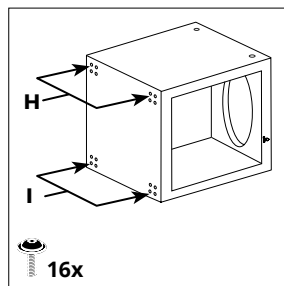
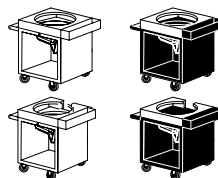
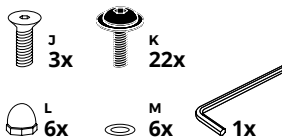

7. ISTRUZIONI PER IL MONTAGGIO

7.2 OFYR® KAMADO TABLE 135 PRO

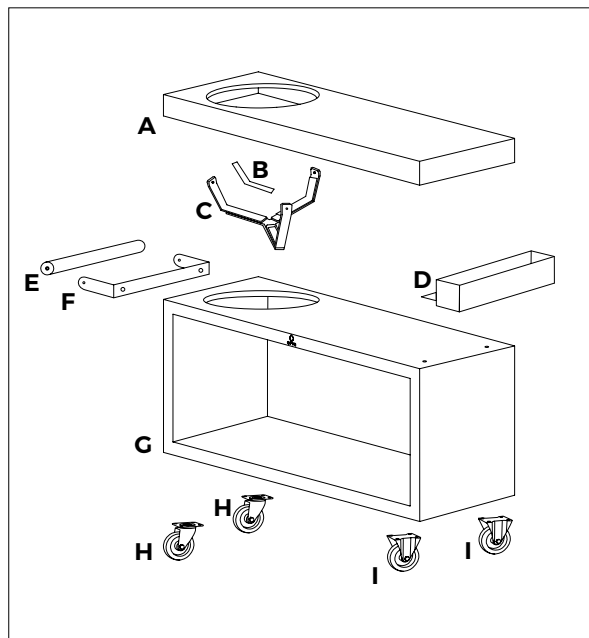

ELENCO DEI COMPONENTI

- A. Blocco di legno
- B. Feltro (3x)
- C. basamento
- D. Tooltray
- E. Parte in legno dell'impugnatura
- F. Parte metallica dell'impugnatura
- G. Base
- H. Ruote girevoli
- I. Ruote fisse

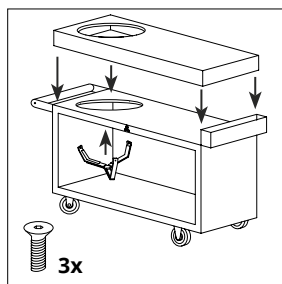
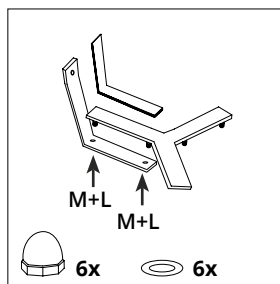
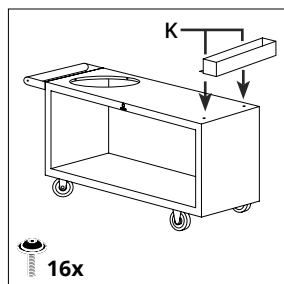
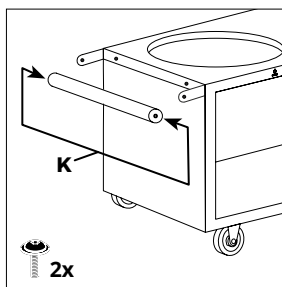
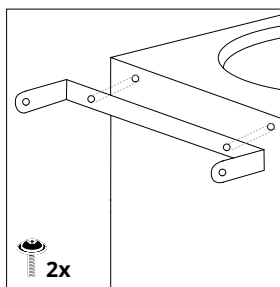
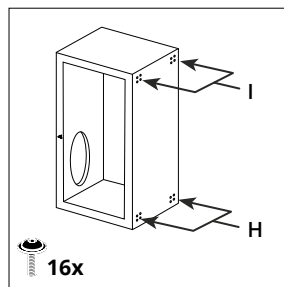
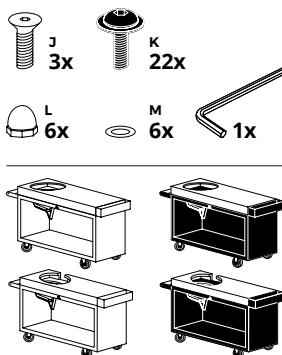

For further information, please contact one of our official distributors or dealers.
www.ofyr.com/store-locator

Copyright OFYR.

All rights reserved.

OFYR Global B.V.

Gewenten 43A
4704 RE Roosendaal
Nederland

+31 (0)165 74 31 10
info@ofyr.com
www.ofyr.com



The design of some OFYR products have EU registration under no 02580431-0001/2, no 003122373-0001 and no 007454590-0001. US Design Patents are registered under no US D798099 S and no US D830095 S.

